

Thumb Turns & Coin Releases

Two designs of both Thumb Turn and Coin Release available as sets or individually - each with the choice of either a Square Spindle that can be fitted in the square or diamond orientation, or a Splined Spindle to operate a Mortice Rack Bolt (see page MC3:070).

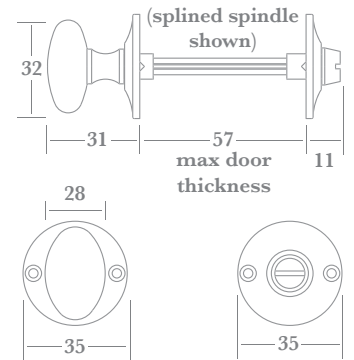

approx actual size

- ▲ 0524 Turn & Coin Release Set (Splined Spindle)
- 0523 Turn only (Splined Spindle)
- 0534 Turn & Coin Release Set (Square Spindle)
- 0533 Turn only (Square Spindle)
- 0532 Coin Release only (Universal Hub)

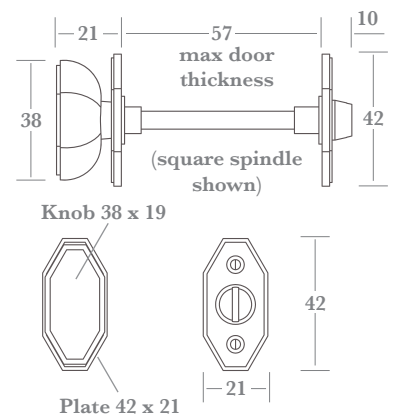
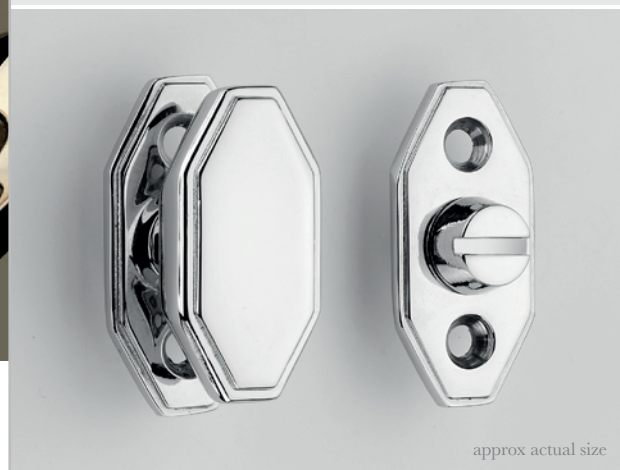

approx actual size

- ▲ 9433 Turn & Coin Release Set (Splined Spindle)
- 9431 Turn only (Splined Spindle)
- 9434 Turn & Coin Release Set (Square Spindle)
- 9421 Turn only (Square Spindle)
- 9432 Coin Release only (Universal Hub)

Fixings

Turns & Releases supplied with finish matched no.4 x 13mm woodscrews.

Turn Sets and Turns only are supplied with a splined spindle or 4.8mm x 65mm square spindle (can be fitted in square or diamond orientation). Longer spindles are available upon request. Coin releases have a Universal Hub to accept both square and splined spindles.

How to Order

Split Finish Sets - order as singles

- 1) select PRODUCT (e.g. 9434)
 - 2) add FINISH (e.g. 9434PB).
- CONVERTER SLEEVE ordered separately if required (e.g. 0150).

Finishes - See our price list or website for finish availability.

0150 - supplied mill finish brass only.

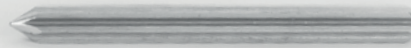

▲ splined spindle - 65mm long (brass)



▲ 4.8mm x 65mm square spindle (brass)

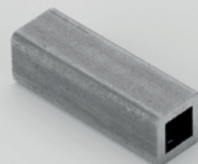

▲ 0150 4.8mm to 8mm Converter Sleeve



Thumb Turns & Releases

A Thumb Turn with a Swing Cover Release and separate Key available as a set or individually along with a Thumb Turn and Coin Release with the option of red/green status indication, again available as sets or individually.



▲ **9420 Turn & Coin Release Set**
9416 Turn only
9418 Coin Release only



▲ **9419 Turn & Coin Release Set**
9416 Turn only
9417 Coin Release only



▲ **9424 Turn & Swing Cover Release Set**
9421 Turn only
7963 Swing Cover Release only



▲ nickel plated key supplied with 9424 & 7963 only

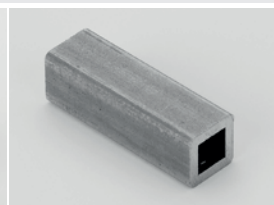

▲ **0150 4.8mm to 8mm Converter Sleeve**

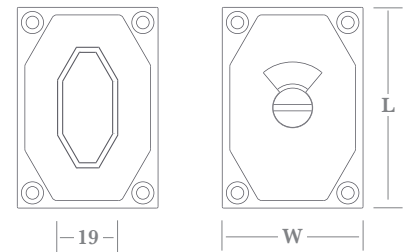
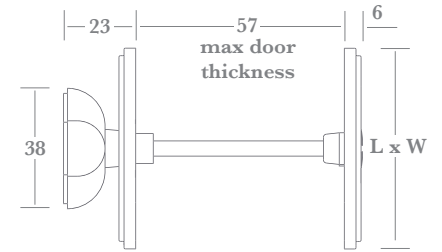

indicator: red / green

	A	B
L x W	50 x 38	63 x 43

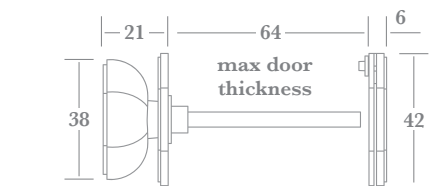

Knob 38 x 19

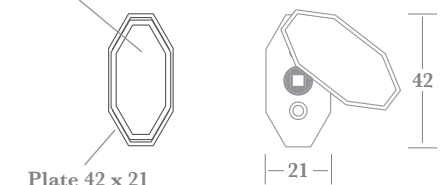

Plate 42 x 21



Fixings

9421, 9424 & 7963 supplied with finish matched no.4 x 13mm wood screws.

9416 - 9420 supplied with finish matched no.6 x 19mm wood screws.

All Turn Sets and Turns only are supplied with a 4.8mm x 65mm square brass spindle (can be fitted in square or diamond orientation). Longer spindles are available upon request.

How to Order

Split Finish Sets - order as singles

1) select TURN/RELEASE (e.g. **9420**)

2) add FINISH (e.g. 9420**PB**).

9416 - 20 add size (e.g. 9416**PB/A**).

CONVERTER SLEEVE ordered separately if required (e.g. **0150**).

Finishes - See our price list or website for finish availability.

0150 - supplied mill finish brass only.

Thumb Turns & Coin Releases

A Thumb Turn with three Turn designs along with a coordinating Coin Release with either no indicator or red/green status indication available as sets or to order individually.



0148 shown

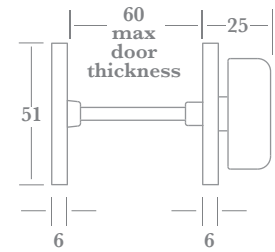

▲ **0148 Turn & Release Set With Indication** (Turn only **0139**, Release only **0140**)
0149 Turn & Release Set No Indicator (Turn only **0139**, Release only **0141**)



0144 shown

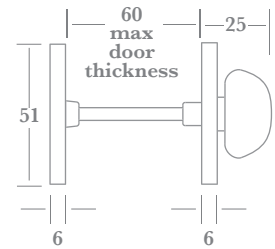

▲ **0144 Turn & Release Set With Indication** (Turn only **0142**, Release only **0140**)
0143 Turn & Release Set No Indicator (Turn only **0142**, Release only **0141**)

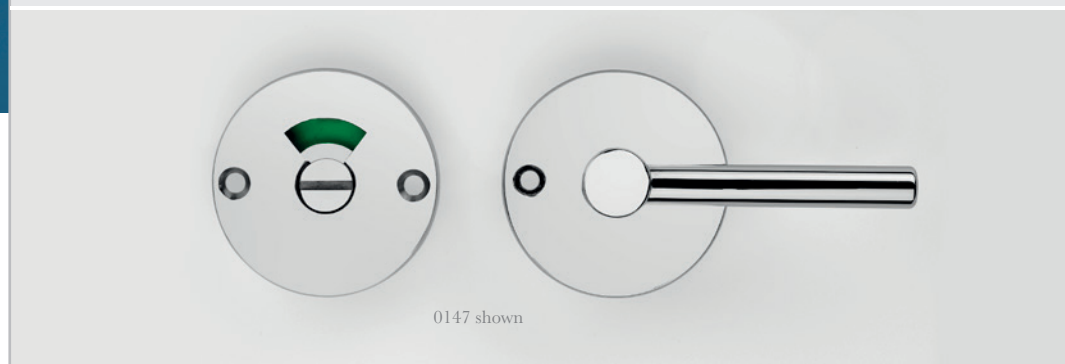

0147 shown

▲ **0147 Turn & Release Set With Indication** (Turn only **0145**, Release only **0140**)
0146 Turn & Release Set No Indicator (Turn only **0145**, Release only **0141**)

Fixings

Turns & Releases supplied with finish matched no.6 x 25mm woodscrews.

Turn Sets and Turns only are supplied with a 4.8mm x 65mm square brass spindle (can be fitted in square or diamond orientation). Longer spindles are available upon request.

How to Order

Split Finish Sets - order as singles

- 1) select PRODUCT (e.g. **0148**)
 - 2) add FINISH (e.g. **0148PB**).
- CONVERTER SLEEVE ordered separately if required (e.g. **0150**).

Finishes - See our price list or website for finish availability.

0150 - supplied mill finish brass only.

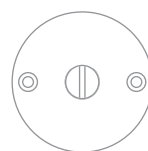

no indicator

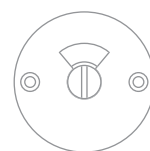

indication: red / green

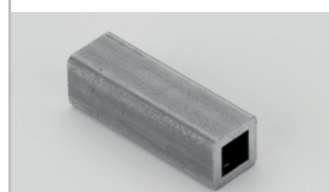
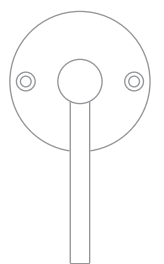
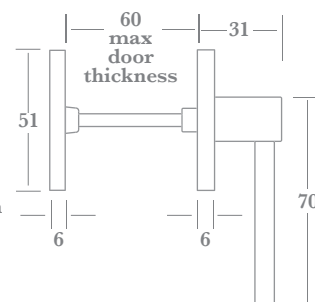

▲ **0150 4.8mm to 8mm Converter Sleeve**

Thumb Turns & Coin Releases

Three Thumb Turn Knob designs available with three Backplate/Rosette options - all supplied with a factory-fitted integral spindle together with complementary Coin Releases.

The 7903/04/10 Oval Backplate Turns can be adapted for use with Legge 3722LK & 3724LK Bathroom Locks - please contact us for coding information.



Fixings

Supplied with finish matched no.4 x 13mm wood screws.

Turns are supplied fitted with a 5mm square spindle in either square or diamond orientation which must be specified (see below).



Release Keys are **not** supplied with Turns - see page ST6:070 to order separately.

How to Order

- 1) select TURN/RELEASE (e.g. 7902)
- 2) add FINISH (e.g. 7902PB)
- 3) Turns only - add SPINDLE ORIENTATION (e.g. 7902PB/DMD).

For CLOSET SPINDLE fitted instead of 5mm spindle add CLS (e.g. 7902PB/DMD/CLS)

If your Turn is to be used along with a Coin Release AND the door thickness is between 66mm and 90mm thick you will need to add XL to your code (e.g. 7902PB/DMD/XL).



A 5-8mm converter sleeve is available - see page ST6:070

Finishes - See our price list or website for finish availability.

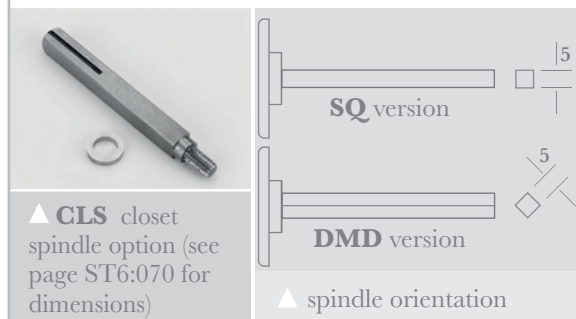
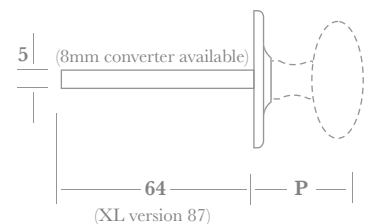
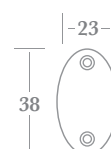
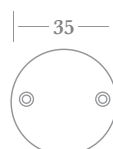
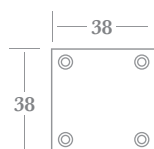
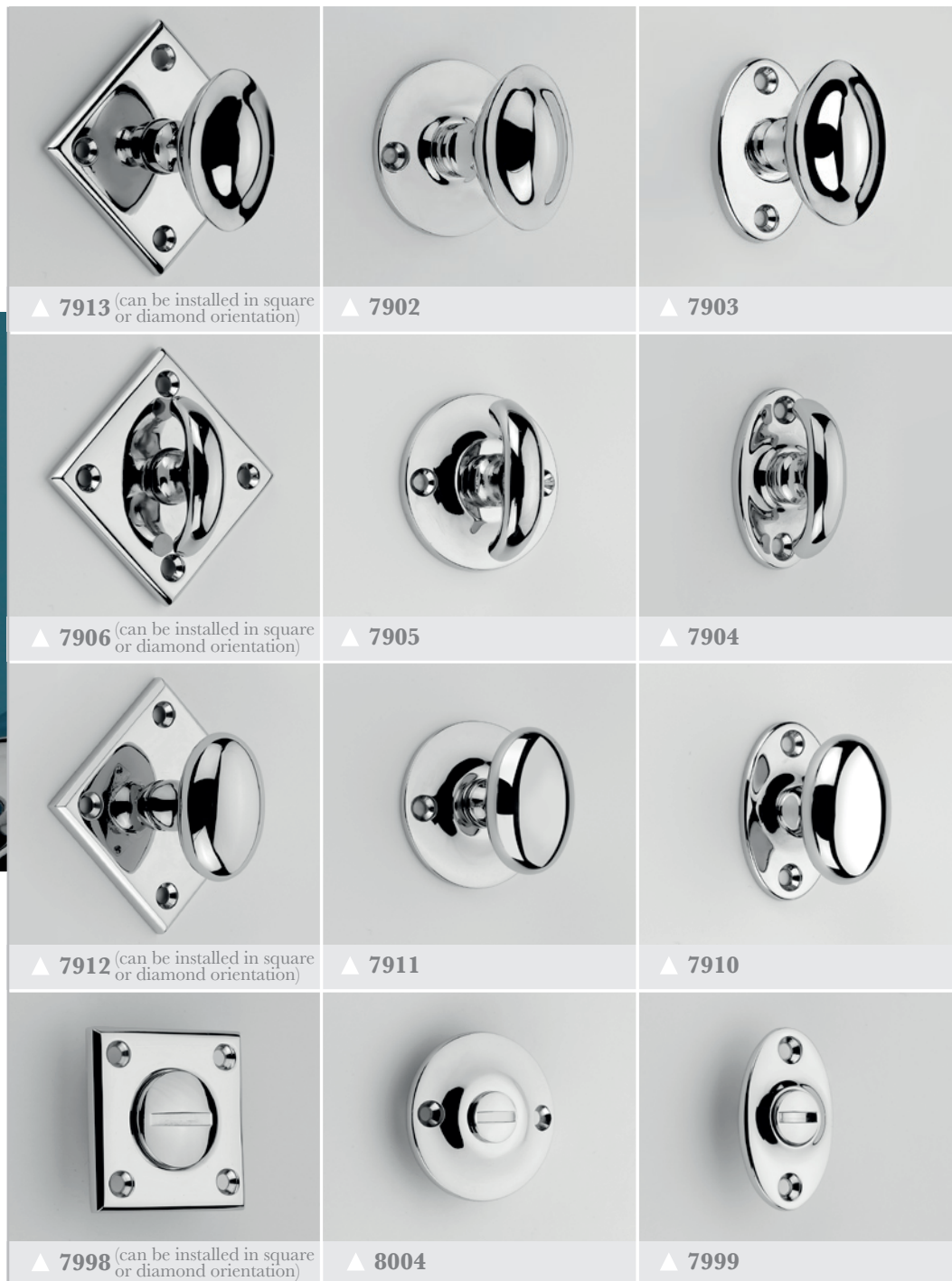

▲ **CLS** closet spindle option (see page ST6:070 for dimensions)

▲ spindle orientation

	Turn size	P (proj)
7904/7905/7906	34 x 9	20
7910/7911/7912	32 x 21	30
7902/7903/7913	32 x 23	36

Thumb Turns & Coin Releases



▲ **7894** 50 x 19



▲ **7890** 50 x 22



▲ **7891** 50 x 19



▲ **7892** 50 x 19



▲ **7893** 50 x 19

Five Thumb Turn Knobs on Backplates, all supplied with a factory-fitted integral spindle; together with complementary Coin Releases.

Fixings

Supplied with finish matched no.4 x 13mm wood screws. Turns are supplied fitted with a 5mm square spindle in either square or diamond orientation which must be specified (see below).



Release Keys are **not** supplied with Turns - see page ST6:070 to order separately.

How to Order

- 1) select TURN/COIN RELEASE (e.g. **7890**)
- 2) add FINISH (e.g. **7890PB**)
- 3) Turns only - add SPINDLE ORIENTATION (e.g. **7890PB/DMD**).

For CLOSET SPINDLE fitted instead of 5mm spindle add **CLS** (e.g. **7890PB/DMD/CLS**)

If your Turn is to be used along with a Coin Release AND the door thickness is between 66mm and 90mm thick you will need to add **XL** to your code (e.g. **7890PB/DMD/XL**).



A 5-8mm converter sleeve is available - see page ST6:070

Finishes - See our price list or website for finish availability.



▲ **7890CR** 50 x 22



▲ **7891CR** 50 x 19



▲ **7892CR** 50 x 19



▲ **7893CR** 50 x 19

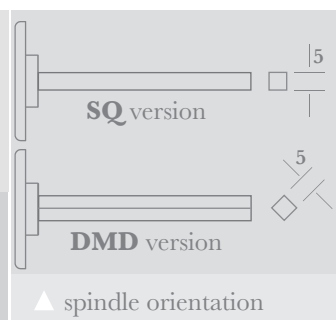
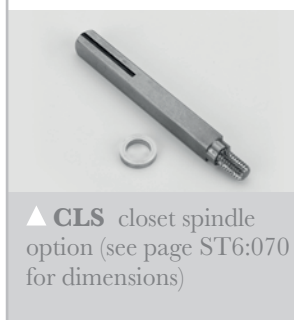
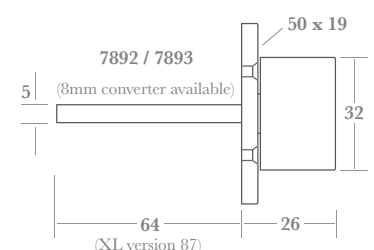
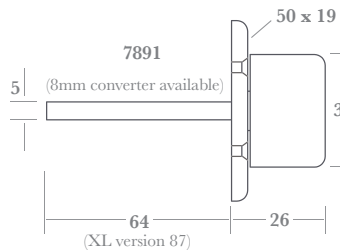
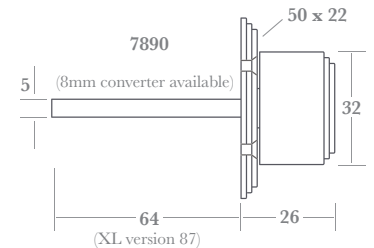
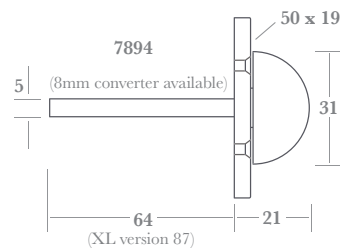

Thumb Turns & Coin Releases

Three classic Art Deco period Thumb Turn Knobs on Plates, all supplied with a factory-fitted integral spindle; together with complementary Coin Releases.

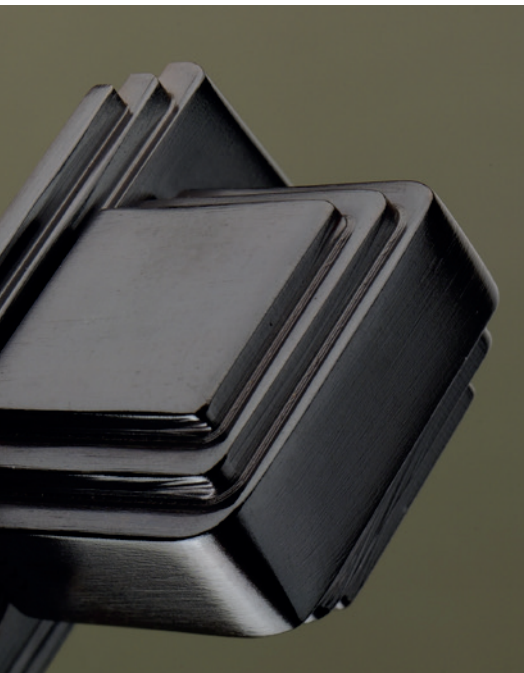

Fixings

Supplied with finish matched no.4 x 13mm wood screws. Turns are supplied fitted with a 5mm square spindle in either square or diamond orientation which must be specified (see below).



Release Keys are **not** supplied with Turns - see page ST6:070 to order separately.

How to Order

- 1) select TURN/COIN RELEASE (e.g. **7900**)
- 2) add FINISH (e.g. **7900PB**)
- 3) 7900 & 7901 only - add SIZE (e.g. **7900PB/B**)
- 4) Turns only - add SPINDLE ORIENTATION (e.g. **7900PB/B/DMD**).

For CLOSET SPINDLE fitted instead of 5mm spindle add **CLS** (e.g. **7900PB/B/DMD/CLS**)

If your Turn is to be used along with a Coin Release AND the door thickness is between 66mm and 90mm thick you will need to add **XL** to your code (e.g. **7900PB/B/DMD/XL**).



A 5-8mm converter sleeve is available - see page ST6:070

Finishes - See our price list or website for finish availability.

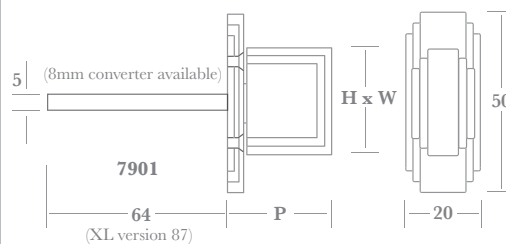
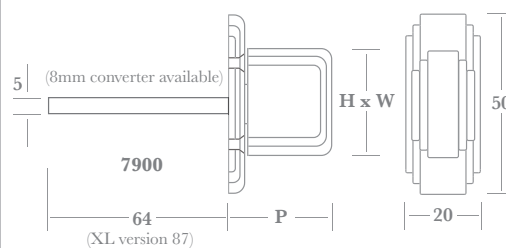

7900/7901	A	B
H x W	25 x 13	30 x 17
P (projection)	26	30
Plate size	50 x 20	50 x 20

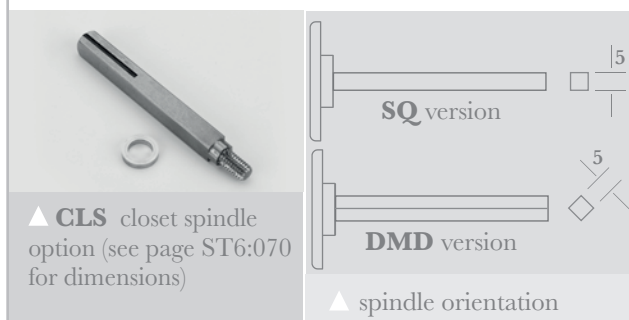
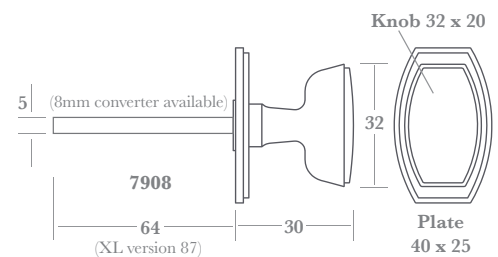
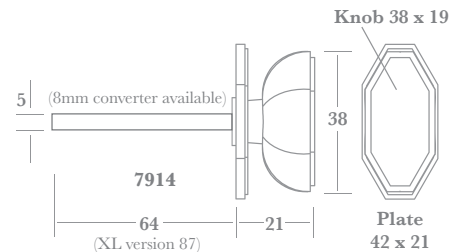

Swing Cover Releases/Escutcheons

A selection of traditional and contemporary Swing Cover Releases and Swing Cover Keyhole Escutcheons designed to complement the Door Knobs & Door Levers in both the Allart Select and Door Furniture sections (ST1&2 and DF1&2).



swing cover release (7961SC shown)

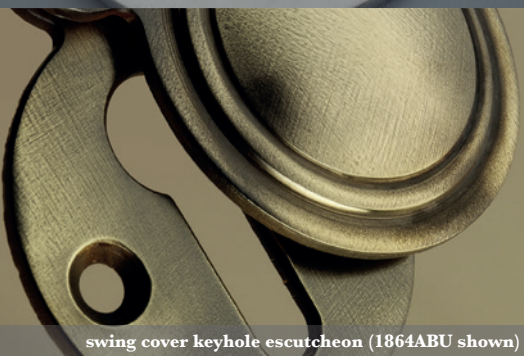

swing cover keyhole escutcheon (1864ABU shown)

Fixings

Supplied with finish matched no.4 x 13mm wood screws.
Swing Cover Releases supplied with nickel plated key.

How to Order

- 1) select RELEASE or ESCUTCHEON (e.g. 7967)
- 2) add FINISH (e.g. 7967PB).

Finishes - See our price list or website for finish availability.

 0173 & 0174 available in solid bronze finishes only.

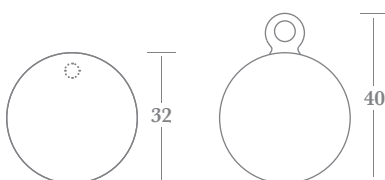

approx actual size

▲ 8980 Release/8990 Escutcheon



approx actual size

▲ 7962 Release/1867 Escutcheon



approx actual size

▲ 7961 Release/1864 Escutcheon



approx actual size

▲ 7964 Release/1880 Escutcheon



approx actual size

▲ 7967 Release/1868 Escutcheon



approx actual size

▲ 7968 Release/3924 Escutcheon



square edge design

approx actual size

▲ 7965 Release/7970 Escutcheon



round edge design

approx actual size

▲ 7966 Release/7971 Escutcheon



approx actual size

▲ 0174 Release/0173 Escutcheon



approx actual size

▲ 0176 Release/0175 Escutcheon



Swing Cover Releases supplied with nickel plated key (see page ST6:070 for dimensions)

Swing Cover Releases/Escutcheons

A selection of traditional and contemporary Swing Cover Releases and Swing Cover Keyhole Escutcheons designed to complement the Door Knobs & Door Levers in both the Allart Select and Door Furniture sections (ST1&2 and DF1&2).

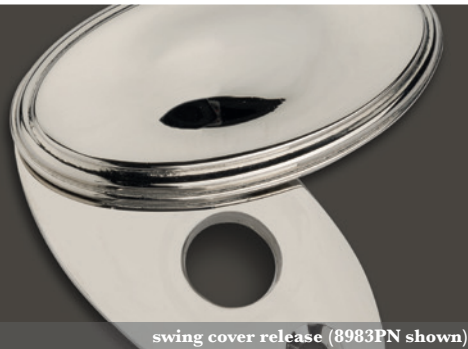

swing cover release (8983PN shown)



swing cover keyhole escutcheon (8993ABU shown)

Fixings

Supplied with finish matched no.4 x 13mm wood screws.
Swing Cover Releases supplied with nickel plated key.

How to Order

- 1) select RELEASE or ESCUTCHEON (e.g. **8987**)
- 2) add FINISH (e.g. 8987**PB**).

Finishes - See our price list or website for finish availability.



▲ **8984** Release/**8994** Escutcheon 40 x 31



▲ **8983** Release/**8993** Escutcheon 45 x 24



▲ **8989** Release/**8999** Escutcheon 50 x 19



▲ **8981** Release/**8991** Escutcheon 50 x 19



▲ **8985** Release/**8995** Escutcheon 50 x 19



▲ **8986** Release/**8996** Escutcheon 50 x 19



▲ **8987** Release/**8997** Escutcheon 32 ^{A_F}

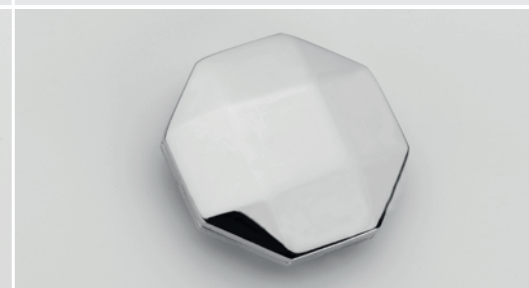

▲ **8988** Release/**8998** Escutcheon 32 ^{A_F}



▲ **8982** Release/**8992** Escutcheon 40 x 25

^{A_F} = dimension across flats



Swing Cover Releases supplied with nickel plated key (see page ST6:070 for dimensions)

Swing Cover Releases/Escutcheons

A selection of traditional and contemporary Swing Cover Releases and Swing Cover Keyhole Escutcheons designed to complement the Door Knobs & Door Levers in both the Allart Select and Door Furniture sections (ST1&2 and DF1&2).



swing cover keyhole escutcheon (0155PC shown)

Fixings

Supplied with finish matched no.4 x 13mm wood screws.
Swing Cover Releases supplied with nickel plated key.

How to Order

- 1) select RELEASE or ESCUTCHEON (e.g. **7975**)
- 2) add FINISH (e.g. 7975**PB**).

Finishes - See our price list or website for finish availability.



▲ **1876** Escutcheon 57 x 32
(keyhole escutcheon only, no release version available)



▲ **0155** Escutcheon 57 x 19
(keyhole escutcheon only, no release version available)



▲ **7976** Release/**9158** Escutcheon 45 x 25



▲ **1878** Release/**1879** Escutcheon 44 x 32



▲ **7963** Release/**9402** Escutcheon 40 x 20



▲ **7977** Release/**2523** Escutcheon 56 x 27



round edge design

▲ **7974** Release/**7972** Escutcheon 50 x 20

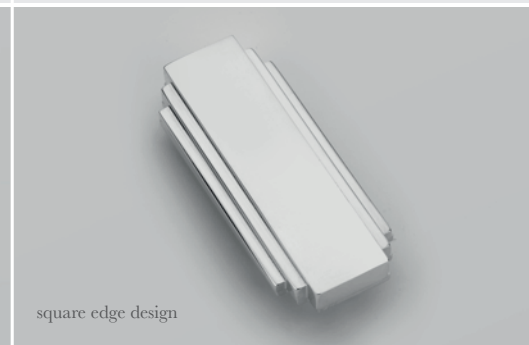

square edge design

▲ **7975** Release/**7973** Escutcheon 50 x 20



9403 shown

▲ **9404** Release/**9403** Escutcheon 50 x 38



Swing Cover Releases supplied with nickel plated key (see page ST6:070 for dimensions)

Escutcheons & Release Key Ferrules

A selection of traditional Keyhole Escutcheons, both flat and sunken keyway (designed to cater for thick doors where key projection is a problem), along with a Budget Lock Escutcheon and three Release Key Ferrules.



▲ 7897



▲ 7898

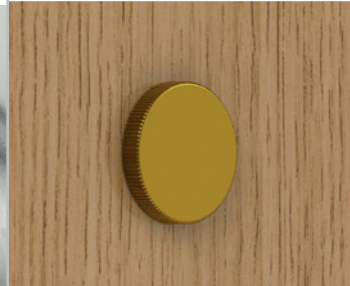
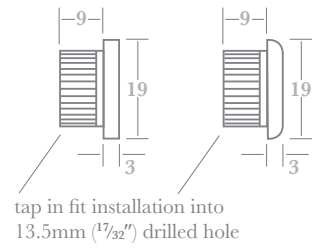

▲ 7899

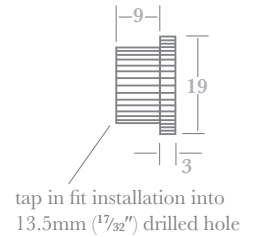

▲ 1871 44 x 29



▲ 1849 51 x 22



▲ 7978 38 x 38

Fixings

Escutcheons supplied with finish matched no.4 x 13mm wood screws (except 1849 which is supplied with no.6 x 19mm). Release Key Ferrules require a 13.5mm (1/2") drilled hole for tap in installation (please ensure finished face is protected).



▲ 0169 44 diameter



▲ 1885 32 diameter



▲ 2100 28 x 17

How to Order

- 1) select ESCUTCHEON/FERRULE (e.g. 1871)
- 2) add FINISH (e.g. 1871PC).

Finishes - See our price list or website for finish availability.



▲ 0159 57 diameter

Escutcheons - Concealed fix - 44mm to 76mm Ø

A concealed fix standard keyhole escutcheon offered in twelve designs and up to four sizes to match up with the Allart Select Rosettes and Backplates.

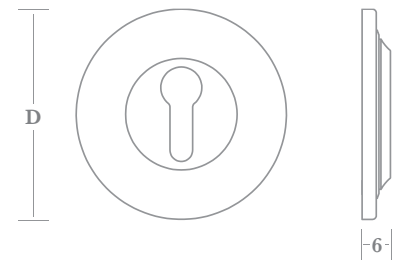

	A	B	C	D
D (diameter)	Ø 44	Ø 54	Ø 64	Ø 76

Custom sizes available upon request - surcharge may apply.

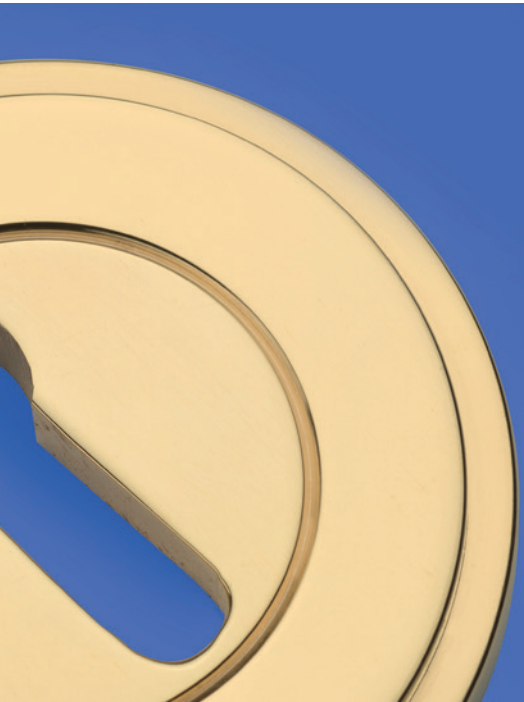

▲ 7578

computer generated images (A size shown)

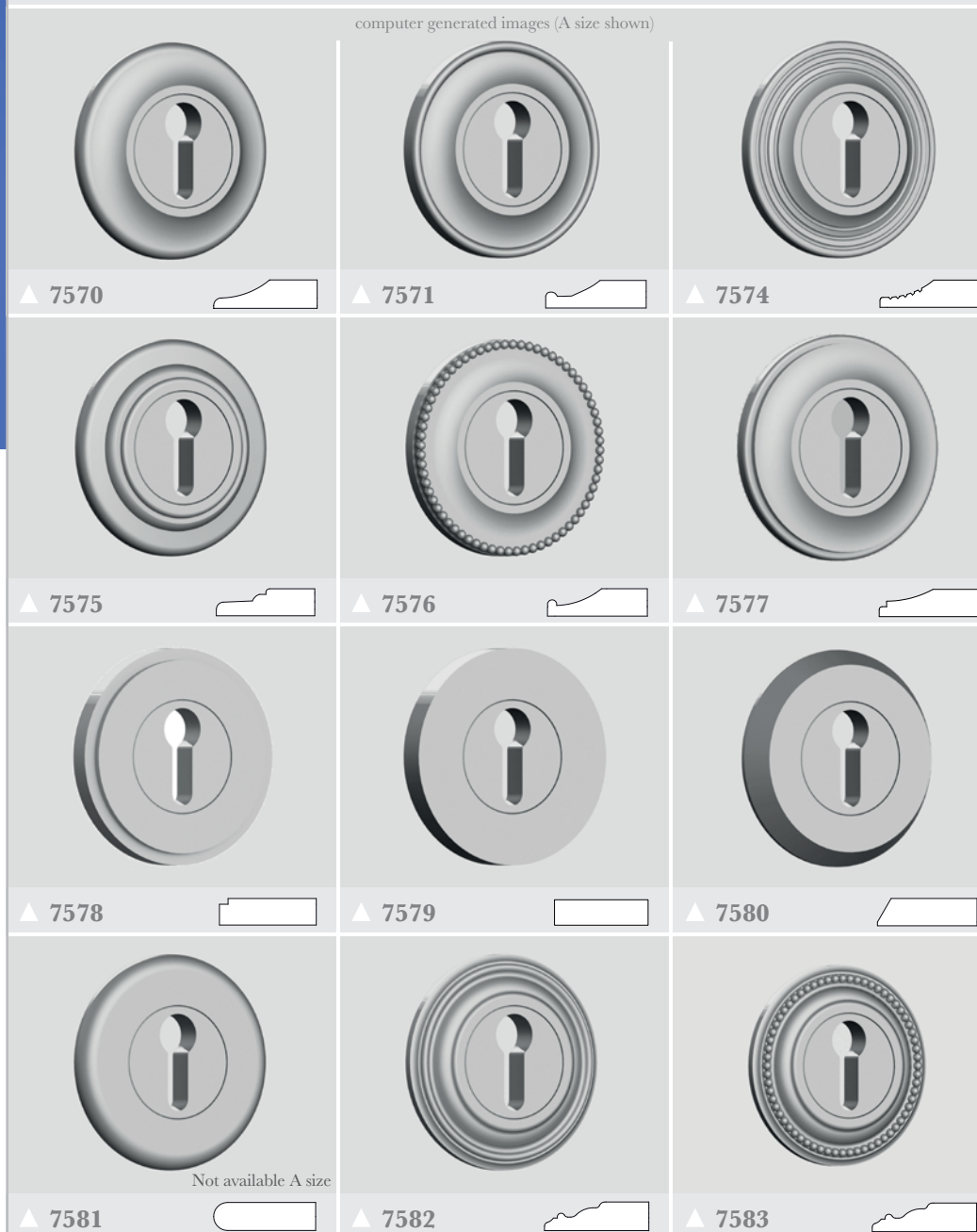

Fixings

Supplied with subrose and no.4 x 13mm wood screws.

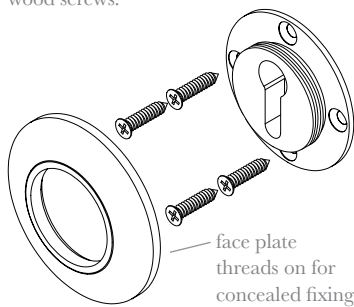

How to Order

- 1) select ROSETTE DESIGN (e.g. 7570)
- 2) add SIZE (e.g. 7570B)
- 3) add FINISH (e.g. 7570B/PB)

Finishes - See our price list or website for finish availability.

Cylinder Escutcheons & Collars

A selection of traditional and contemporary Escutcheons, both face fixed and concealed fix, available either with profile cylinder cutouts or with traditional keyholes.

Additionally the 9411 is also available as a Cylinder Collar, to suit both UK and US standard rim cylinders.

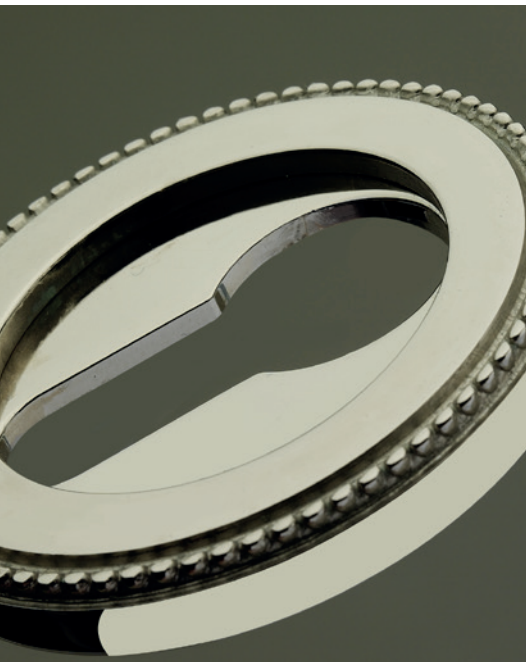

▲ **1893** 50 diameter



▲ **3928** 50 diameter



3007 shown

▲ **3007** 50 diameter 3.0 thick
▲ **3008** 50 diameter 1.6 thick

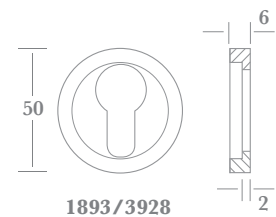

9405 shown

▲ **9405** 50 x 38 x 5
▲ **9411** 63 x 43 x 6

Fixings

3007 & 3008 supplied with finished matched no.4 x 13mm wood screws.

9405 & 9411 supplied with finished matched no.6 x 19mm wood screws.

1893 & 3928 supplied with no.4 x 13mm wood screws and face plates thread on for concealed fixing.

How to Order

- 1) select ESCUTCHEON (e.g. **1893**)
- 2) add FINISH (e.g. 1893**PC**)
- 3) add PROFILE (e.g. 1893**PC/O**).

Cylinder Collar (9411 only):

- 1) add FINISH (e.g. 9411**PC**)
- 2) add CYLINDER SIZE (e.g. 9411**PC/UK** or 9411**PC/US**).



▲ **Cylinder Collar**
UK or US (9411 only)



▲ **oval cylinder (O)†**



▲ **euro cylinder (E)**



▲ **standard keyhole (S)**

Cylinder flange not recessed



† cutout for standard 32 x 18mm oval cylinder (larger cutouts available upon request)

Cylinder type	(D)
UK standard	30
US standard	32

Finishes - See our price list or website for finish availability.

Cylinder Escutcheons & Cylinder Collars

Four Cylinder Escutcheon / Cylinder Collar designs, each offered in up to three sizes.

The Cylinder Collar version is available machined to suit either a UK or US specification cylinder.

The Euro & Oval Cylinder versions are designed with grub screw attachment to the cylinder underside. The application of a small amount of contact adhesive to the rear of the Escutcheon is recommended.

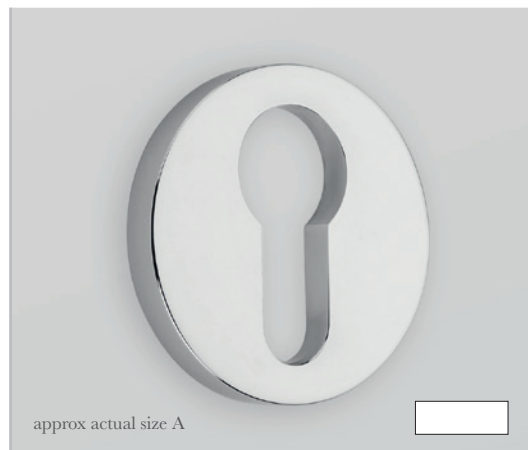
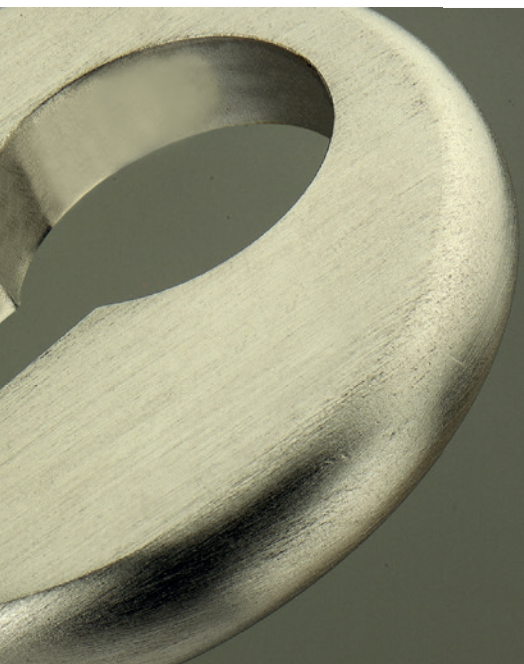

approx actual size A

▲ 7987

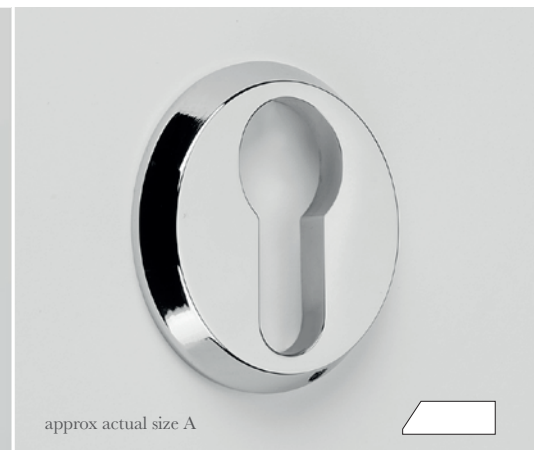

approx actual size A

▲ 7988



approx actual size A

▲ 7986

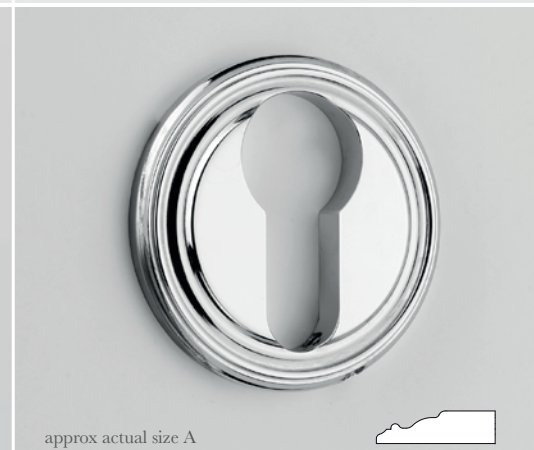

approx actual size A

▲ 7989



▲ cylinder collar (UK/US)



▲ euro cylinder (E)



▲ oval cylinder (O)†

†cutout for standard 32 x 18mm oval cylinder (larger cutouts available upon request)

Fixings

Oval & Euro Profile cutouts only - supplied with grub screw for fixing to cylinder. The application of a small amount of contact adhesive to the rear of the Escutcheon is recommended.

How to Order

- 1) select ESCUTCHEON (e.g. 7986)
- 2) add SIZE (e.g. 7986B)
- 3) add PROFILE (e.g. 7986B/O)
- 4) add FINISH (e.g. 7986B/O/PC).

Cylinder Collar:

- 1) select COLLAR (e.g. 7986)
- 2) add SIZE (e.g. 7986B)
- 3) add CYLINDER TYPE (e.g. 7986B/US)
- 4) add FINISH (e.g. 7986B/US/PC).

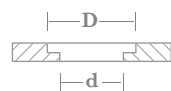

code	Cylinder type	D	d
UK	UK standard	33	30
US	US standard	35	32

6 (except 7989 = 7mm)

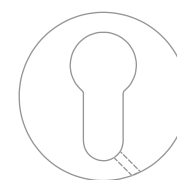

grubscrew position

	A	B	C
D (dia)	44 Ø	54 Ø	64 Ø

Custom sizes available upon request - surcharge may apply.

Finishes - See our price list or website for finish availability.

Cylinder Escutcheons & Cylinder Collars

Six Cylinder Escutcheon / Cylinder Collar designs, each offered in up to three sizes.

The Cylinder Collar version is available machined to suit either a UK or US specification cylinder.

The Euro & Oval Cylinder versions are designed with grub screw attachment to the cylinder underside. The application of a small amount of contact adhesive to the rear of the Escutcheon is recommended.



Fixings

Oval & Euro Profile cutouts only - supplied with grub screw for fixing to cylinder. The application of a small amount of contact adhesive to the rear of the Escutcheon is recommended.

How to Order

Oval & Euro Profiles:

- 1) select ESCUTCHEON (e.g. **7985**)
- 2) add SIZE (e.g. **7985B**)
- 3) add PROFILE (e.g. **7985B/O**)
- 4) add FINISH (e.g. **7985B/O/PC**).

Cylinder Collar:

- 1) select COLLAR (e.g. **7985**)
- 2) add SIZE (e.g. **7985B**)
- 3) add CYLINDER TYPE (e.g. **7985B/US**).
- 4) add FINISH (e.g. **7985B/US/PC**).

▲ **cylinder collar (UK/US)**

▲ **euro cylinder (E)**

▲ **oval cylinder (O)†**

† cutout for standard 32 x 18mm oval cylinder (larger cutouts available upon request)

code	Cylinder type	D	d
UK	UK standard	33	30
US	US standard	35	32

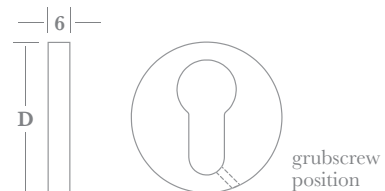

	A	B	C
D (dia)	44 Ø	54 Ø	64 Ø

Custom sizes available upon request - surcharge may apply.

Finishes - See our price list or website for finish availability.

Euro-Profile Escutcheons - 54mm to 76mm Ø

A concealed fix euro-profile cylinder escutcheon offered in twelve designs and three sizes to match up with the Allart Select Rosettes and Backplates.



approx actual size B

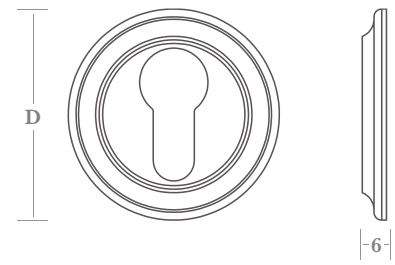

	A	B	C	D
D (diameter)	-	Ø 54	Ø 64	Ø 76

Custom sizes available upon request - surcharge may apply.

▲ 7412

computer generated images (B size shown)



▲ 7400



▲ 7401



▲ 7404



▲ 7405



▲ 7406



▲ 7407



▲ 7408



▲ 7409



▲ 7410



▲ 7411



▲ 7412



▲ 7413

Fixings

Supplied with no.4 x 13mm wood screws.

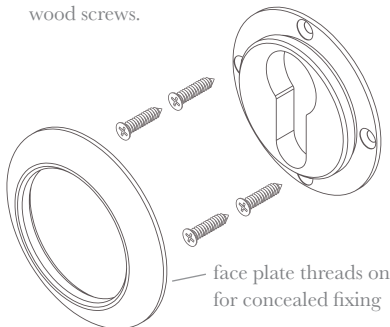

BLANKS

Matching blanks (ie no euro profile cutout) are available in all designs and sizes.



How to Order

- 1) select ESCUTCHEON (e.g. 7400)
 - 2) add SIZE (e.g. 7400B)
 - 3) add FINISH (e.g. 7400B/PB)
- For blank/no cutout add BLANK (e.g. 7400B/PB/BLANK).

Finishes - See our price list or website for finish availability.

Cylinder Escutcheons & Cylinder Collars

Four Cylinder Escutcheon / Cylinder Collar Diamond orientated Plate designs - each available in three sizes.

The Cylinder Collar version is offered machined to suit either a UK or US specification cylinder.

The Euro & Oval Cylinder versions are offered either Face Fixed or Concealed Fix - the Concealed Fixing being achieved using grub screw attachment to the cylinder underside. The application of a small amount of contact adhesive to the rear of the Escutcheon is recommended.

The standard bit-key Keyhole version is available Face Fixed only.



Fixings

Concealed fix Escutcheons supplied with grub screw for fixing to cylinder. The application of a small amount of contact adhesive to the rear of the Escutcheon is recommended.

Face fixed Escutcheons supplied with finish matched no.6 x 19mm wood screws. Cylinder Collars supplied with anti-rotation pin.

How to Order

Oval/Euro Profiles & Standard Keyhole:

- 1) select ESCUTCHEON (e.g. 5970)
- 2) add SIZE (e.g. 5970B)
- 3) add PROFILE (e.g. 5970B/E)
- 4) add FINISH (e.g. 5970B/E/PC).

Cylinder Collar (concealed fix only):

- 1) select COLLAR (e.g. 5920)
- 2) add SIZE (e.g. 5920C)
- 3) add CYLINDER TYPE (e.g. 5920C/US)
- 4) add FINISH (e.g. 5920C/US/PC).

Finishes - See our price list or website for finish availability.

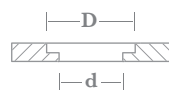
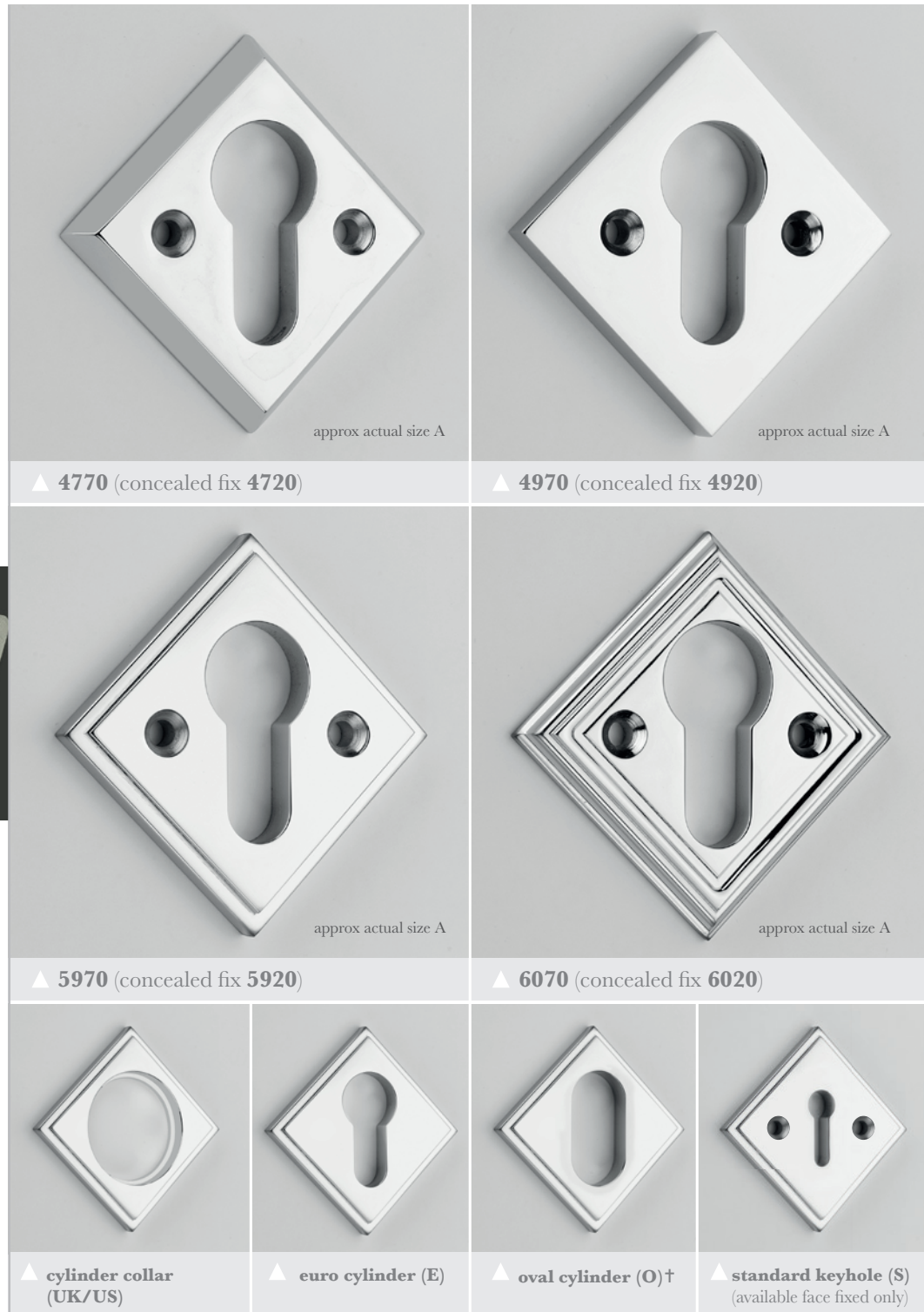

code	Cylinder type	D	d
UK	UK standard	33	30
US	US standard	35	32

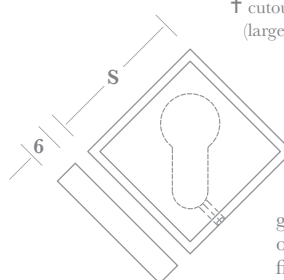

† cutout for standard 32 x 18mm oval cylinder (larger cutouts available upon request)

grubscrew position on concealed fix versions

	A	B	C
S (square)	44	54	64

Custom sizes available upon request - surcharge may apply.

Cylinder Escutcheons & Cylinder Collars

Nine Cylinder Escutcheon / Cylinder Collar Square Plate designs - each available in up to three sizes.

The Cylinder Collar version is offered machined to suit either a UK or US specification cylinder.

The Euro & Oval Cylinder versions are offered either Face Fixed or Concealed Fix - the Concealed Fixing being achieved using grub screw attachment to the cylinder underside. The application of a small amount of contact adhesive to the rear of the Escutcheon is recommended.

The standard bit-key Keyhole version is available Face Fixed only.



All images shown below are A size (44mm)



Fixings

Concealed fix Escutcheons supplied with grub screw for fixing to cylinder. The application of a small amount of contact adhesive to the rear of the Escutcheon is recommended.

Face fixed Escutcheons supplied with finish matched no.6 x 19mm wood screws. (except 6052, 6752 & 6852 A sizes: no.4 x 13mm).

Cylinder Collars supplied with anti-rotation pin.

How to Order

Oval/Euro Profiles & Standard Keyhole:

- 1) select ESCUTCHEON (e.g. **4752**)
- 2) add SIZE (e.g. **4752B**)
- 3) add PROFILE (e.g. **4752B/E**)
- 4) add FINISH (e.g. **4752B/E/PC**).

Cylinder Collar (concealed fix only):

- 1) select COLLAR (e.g. **5902**)
- 2) add SIZE (e.g. **5902C**)
- 3) add CYLINDER TYPE (e.g. **5902C/US**)
- 4) add FINISH (e.g. **5902C/US/PC**).

Finishes - See our price list or website for finish availability.

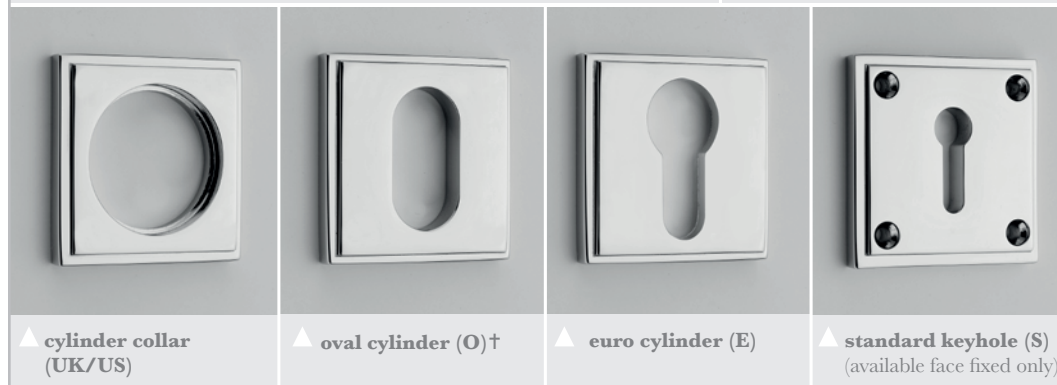

† cutout for standard 32 x 18mm oval cylinder (larger cutouts available upon request)

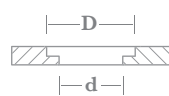

code	Cylinder type	D	d
UK	UK standard	33	30
US	US standard	35	32

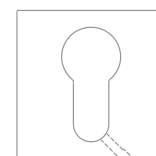
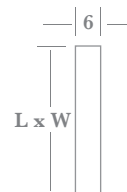

grubscrew position on concealed fix versions

	A	B	C
L x W	44 x 44	54 x 54	64 x 64
3202/52 only	62 x 44	72 x 54	82 x 64

Custom sizes available upon request - surcharge may apply.