

# Appliance Pulls

A selection of Pulls available in a variety of sizes to complement both traditional and modern interiors. They can also be found in the Door Furniture section (see DF3) where most are available fitted to back plates and many are offered in pairs for back-to-back installation.



## Fixings

1433AA & 1433A supplied with finish matched no.6 x 19mm wood screws and M6 x 50mm machine screws (longer screws available upon request).

1433B & 1433C supplied as above, but with finish matched no.8 x 25mm wood screws.

1435AA & 1435A supplied with finish matched no.6 x 19mm wood screws.

1435B & 1435C supplied with finish matched no.8 x 25mm wood screws.

1434, 3934, 6999, 9512 & 9531 supplied with M6 x 50mm machine screws (longer screws available upon request).

4325 supplied with M8 x 50mm machine screws (longer screws available upon request).

## How to Order

- 1) select HANDLE (e.g. **1435**)
  - 2) add FINISH (e.g. **1435PB**)
  - 3) add SIZE, except 3934 & 9531 (e.g. **1435PB/C**).
- 9531 only - add HANDLING (e.g. **9531PC/LH**).

**Finishes** - See our price list or website for finish availability.



▲ 3934

▲ 9531

▲ 6999



▲ 4325

▲ 9512

▲ 1434



▲ 1435  
(face fixed only)  
**1433**  
(face fixed & rear bolt fixing)

	Overall length	Centres	Proj
3934	245	159	58
9531	303	190	54
6999 A	240	216	62
B	270	245	62
4325 A	192	175	47
B	247	226	54
C	336	310	66

	Overall length	Centres	Proj
9512 A	210	190	40
B	254	232	46
1433-5 AA	158	116	42
A	203	152	54
B	254	191	61
C	305	234	68

# Appliance Pulls

A classic Pull, available in three lengths and with twelve Rosette designs, each in up to three diameters, to complement the Allart Select Door Knob & Lever Rosettes (see section ST3) and the Cabinet Knobs shown on pages CF1:060 & 070.



These Pulls can also be found in the Door Furniture section (see DF3) available fitted to back plates and offered in pairs for back-to-back installation.

## Fixings

Supplied with M8 x 50mm machine screws (longer screws available upon request).

## How to Order

- 1) select HANDLE (e.g. 4358)
- 2) add FINISH (e.g. 4358PC)
- 3) add LENGTH (e.g. 4358PC/A)
- 4) add ROSETTE SIZE (e.g. 4358PC/A38).

**Finishes** - See our price list or website for finish availability.



size B Pull shown with 54mm Ø rosettes

▲ 4359

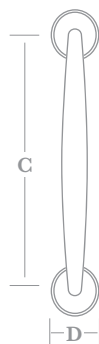

	C (centres)	Projection	D (diameter)
A	175	54	Ø 38
B	226	61	Ø 44, 54, 64
C	310	73	Ø 44, 54, 64

# Appliance Pulls

A traditional Pull, available in two lengths and with eight Rosette designs, each in four diameters, to complement the Allart Select Door Knob & Lever Rosettes (see section ST3) and the Cabinet Knobs shown on pages CF1:060 & 070.



These Pulls can also be found in the Door Furniture section (see DF3) available fitted to back plates and offered in pairs for back-to-back installation.

## Fixings

Supplied with M6 x 50mm machine screws (longer screws available upon request).

## How to Order

- 1) select HANDLE (e.g. 1911)
- 2) add FINISH (e.g. 1911PC)
- 3) add LENGTH (e.g. 1911PC/A)
- 4) add ROSETTE SIZE (e.g. 1911PC/A44).

**Finishes** - See our price list or website for finish availability.

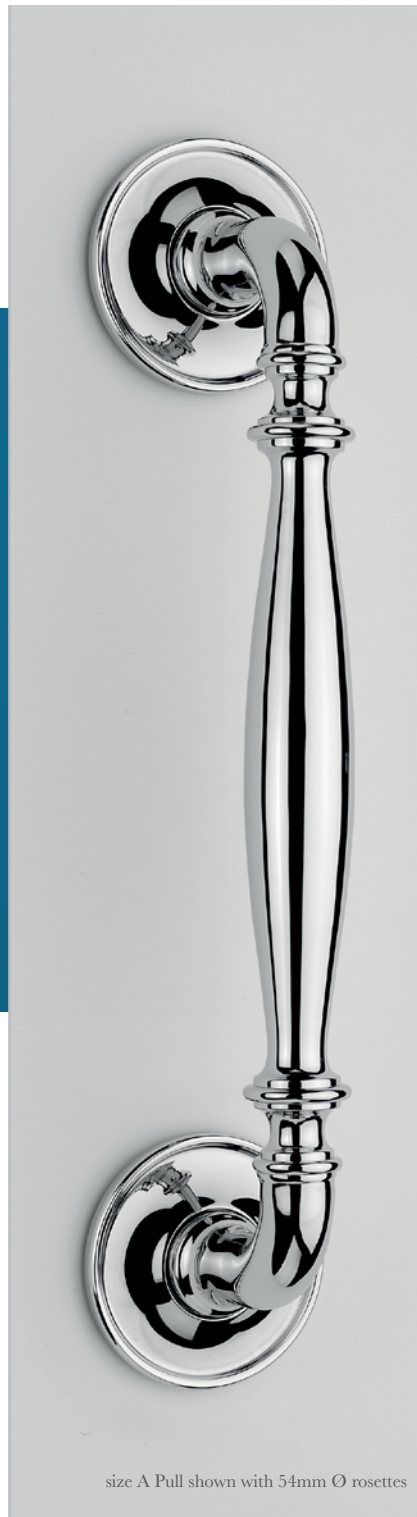

size A Pull shown with 54mm Ø rosettes

▲ 1911



▲ 1910



▲ 1911



▲ 1912



▲ 1913



▲ 1914



▲ 1915



▲ 1916



▲ 1917

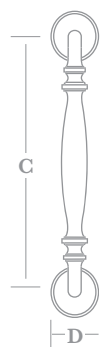

	C (centres)	Projection	D (diameter)
A	209	56	Ø 38, 44, 54, 64
B	241	56	Ø 38, 44, 54, 64

# Appliance Pulls

A traditional offset design Pull, available in two lengths and with eight Rosette designs, each in four diameters, to complement the Allart Select Door Knob & Lever Rosettes (see section ST3) and the Cabinet Knobs shown on pages CF1:060 & 070.



These Pulls can also be found in the Door Furniture section (see DF3) available fitted to back plates and offered in pairs for back-to-back installation.

## Fixings

Supplied with M6 x 50mm machine screws (longer screws available upon request).

## How to Order

- 1) select HANDLE (e.g. **1986**)
- 2) add FINISH (e.g. 1986**PC**)
- 3) add LENGTH (e.g. 1986**PC/A**)
- 4) add ROSETTE SIZE (e.g. 1986**PC/A44**).

**Finishes** - See our price list or website for finish availability.



size A Pull shown with 44mm Ø rosettes

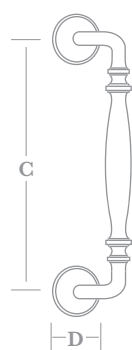

	C (centres)	Projection	D (diameter)
A	218	60	Ø 38, 44, 54, 64
B	250	60	Ø 38, 44, 54, 64

# Bakes Pulls and Bakes Knobs

Classic Robert Bakes designed Pulls & Cabinet Knobs. The Pulls are available in five sizes from 130mm up to 375mm, whilst the Knobs are offered in two sizes.



▲ 0660

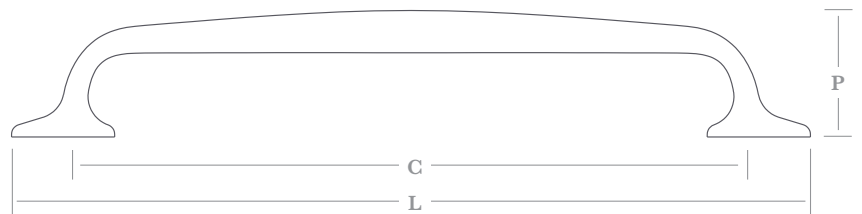

0660	A	B	C	D	E
L (length)	130	155	182	240	375
C (centres)	101	126	152	203	318
P (projection)	26	26	31	38	51

## Fixings

0660A-D supplied with M4 x 50mm break-off machine screws (longer screws available upon request).

0660E supplied with M8 x 50mm machine screws (longer screws available upon request).

0661 supplied with M4 x 50mm break-off machine screws.



Dowel Screw option available

## How to Order

### 0660 Pulls:

- 1) add FINISH (e.g. 0660PC)
- 2) add SIZE (e.g. 0660PC/A)

### 0661 Knobs:

- 1) add FINISH (e.g. 0661PC)
- 2) add SIZE (e.g. 0661PC/B)

Choose DOWEL SCREW option if required (e.g. 0661PC/B/DS).



▲ 0661



0661	A	B
H x W (height x width)	33 x 46	38 x 53
P (projection)	31	35

**Finishes** - See our price list or website for finish availability.

# Cabinet Pulls

A traditional design Cabinet Pull available in three sizes, and three Art Deco design offset Cabinet Pulls to complement the 9512 Appliance Pulls shown on page CF2:010 and the Cabinet Knobs shown on page CF1:040.

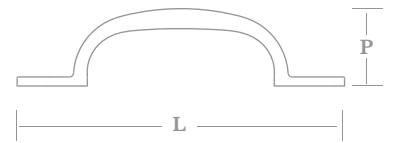

	A	B	C
L (length)	102	127	152
P (projection)	28	30	36

▲ 1436



▲ 9502 rear bolt fix



▲ 9503 rear bolt fix



▲ 9504 face fixed

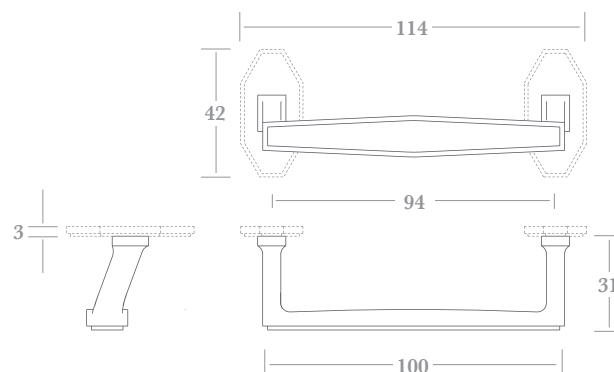

## Fixings

9502 & 9503 supplied with M4 x 50mm break-off machine screws.

1436 & 9504 supplied with finish matched no.6 x 19mm wood screws.

## How to Order

- 1) select HANDLE (e.g. 9503)
  - 2) add FINISH (e.g. 9503PC).
- 1436 only - add SIZE (e.g. 1436PC/A).

**Finishes** - See our price list or website for finish availability.