

Pull Handles

A classic yet contemporary styled offset design offered either plain ended or with a choice of three finial designs, available rear bolt fix, in pairs for back-to-back installation, or adapted for face fixing.

These Pulls can also be fitted to a variety of different Back Plates if desired.



▲ **8046** (face fixed version **8044**)



▲ **8060** (face fixed version **8065**)



▲ **8061** (face fixed version **8066**)



▲ **8062** (face fixed version **8067**)

Fixings

Rear fixing versions supplied with M8 x 50mm machine screws (longer screws available upon request).

Back-to-back fixed pairs supplied with M8 'beefeater' fixing system to suit doors up to 64mm thick.

Face fixed versions supplied with finished matched no.8 x 25mm wood screws.

How to Order

- 1) select HANDLE (e.g. **8066**)
- 2) add FINISH (e.g. **8066PB**)

To order a pair of Handles with BACK-TO-BACK fixing add BTB (e.g. **8061PB/BTB**).

NB. When fitting a BTB pair of Handles to an EXTERIOR door it is important the grub screw fixing is on the internal face - please contact us for coding instructions.

For Pulls fitted to Back Plates - please contact us to discuss available options.

Finishes - See our price list or website for finish availability.



▲ face fixed version base plate design



▲ handles fixed to plates are available

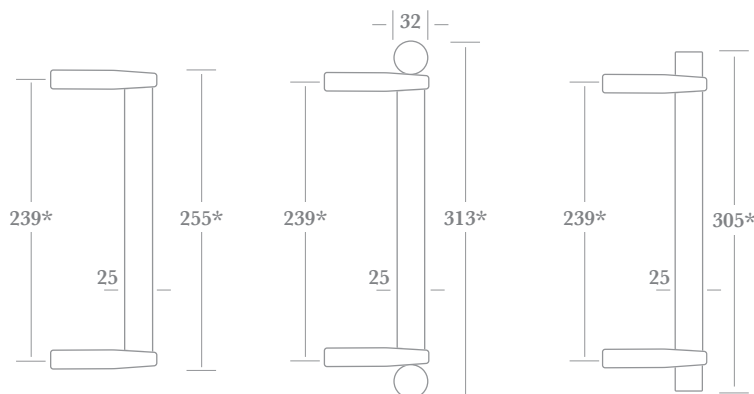

* other lengths are available upon request



Pull Handles

A selection of traditional face fixed, solid cast, offset design Pull Handles.

The 1433-5 design is available with a variety of installation options - including back-to-back fixed.

Complementary Finger Plates can be found on page DF3:150



Fixings

1433AA & 1433A supplied with finish matched no.6 x 19mm wood screws and M6 x 50mm machine screws (longer screws available upon request).

1433B & 1433C supplied as above, but with no.8 x 25mm wood screws.

1442, 1435AA & 1435A supplied with finish matched no.6 x 19mm wood screws.

1435B, 1435C, 1445 & 1446 supplied with no.8 x 25mm wood screws.

1434 supplied with M6 x 50mm machine screws (longer screws available upon request).

1433 & 1434 - Back-to-back fixed pairs supplied with M6 'beefeater' fixing system to suit doors up to 64mm thick.

How to Order

1) select HANDLE (e.g. **1435**)

2) add FINISH (e.g. 1435**PB**)

1433, 1434, 1435 & 1442 only - add SIZE (e.g. 1435**PB/B**).

1433 & 1434 only - to order a pair of Handles with BACK-TO-BACK fixing add BTB (e.g. 1433**PB/B/BTB**)

NB. When fitting a BTB pair of Handles to an EXTERIOR door it is important the grubscrew fixing is on the internal face - please contact us for coding instructions.

For Pulls fitted to Back Plates - please contact us to discuss available options.

Finishes - See our price list or website for finish availability.



▲ **1433** (face fixed & rear bolt fixing)
1435 (face fixed only)

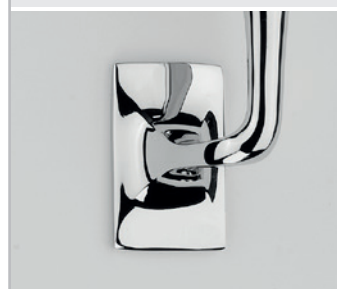

▲ **1434** (rear bolt fixing)



▲ **1442**



▲ **1446**
Matching Finger Plate in solid bronze available - see DF3:150



▲ **1445**

		Overall Length	Centres	Plate width	Projection
1433-5	AA	158	116	-	42
	A	203	152	-	54
	B	254	191	-	61
	C	305	234	-	68
1442	A	152	-	-	36
	B	184	-	-	45
1445		305	-	45	50
1446		305	-	63	65

Pull Handles

A classic straight design Pull, offered in three lengths and available singly for rear bolt fixing, in pairs for back-to-back operation, or with concealed face fixed rosettes.

These Pulls can also be fitted to a variety of different Back Plates if desired.



Fixings

4325 supplied with M8 x 50mm machine screws (longer screws available upon request).

Back-to-back fixed pairs supplied with M8 'beefeater' fixing system to suit doors up to 64mm thick.

4330 supplied with no.6 x 25mm wood screws.

How to Order

1) select HANDLE (e.g. **4325**)

2) add FINISH (e.g. 4325**PC**)

3) add SIZE (e.g. 4325**PC/C**).

4325 only - to order a pair of Handles with BACK-TO-BACK fixing add BTB (e.g. 4325**PC/C/BTB**).

For Pulls fitted to Back Plates - please contact us to discuss available options.

Finishes - See our price list or website for finish availability.



▲ **4325** (rear bolt fixing)

▲ handles fixed to plates are available

▲ **4330** (concealed face fixing)

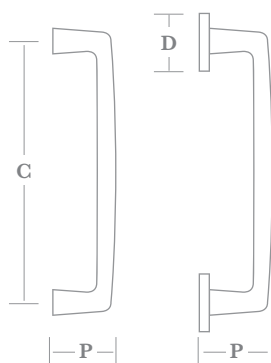

			C (centres)	D (rosette diameter)	P (projection)
4325	A	-	175	-	47
	B	-	226	-	54
	C	-	310	-	66
4330	A	-	175	44	53
	B	-	226	44	60
	C	-	310	51	74

Pull Handles & Finger Plates

A traditional offset design Pull, with or without Back Plate, and matching Finger Plate, offered in two sizes. Pulls in pairs for back-to-back installation are available.

The Back Plate & Finger Plate, manufactured from 3mm thick material, are also available in custom sizes.

The Pulls can be fitted to a variety of different Back Plates if desired.



Fixings

6999 & 7001 supplied with M6 x 50mm machine screws (longer screws available upon request).

7001 also supplied with finish matched no.8 x 25mm wood screws.

Back-to-back fixed pairs supplied with M6 'beefeater' fixing system to suit doors up to 64mm thick.

7002 supplied with finish matched no.6 x 19mm wood screws.

How to Order

- 1) select HANDLE/PLATE (e.g. **7001**)
- 2) add FINISH (e.g. **7001PB**)
- 3) add SIZE (e.g. **7001PB/A**).

6999 & 7001 - to order a pair of Handles with BACK-TO-BACK fixing add BTB (e.g. **6999PB/B/BTB**).

NB. When fitting a BTB pair of Handles to an EXTERIOR door it is important the grubscrew fixing is on the internal face - please contact us for coding instructions.

For Pulls fitted to different Back Plates - please contact us to discuss available options.

Finishes - See our price list or website for finish availability.



▲ **7001**

▲ **6999**
(rear bolt fixing)

▲ **7002**

			Overall length	Centres	Plate width	Projection
6999	A	-	240	216	-	62
	B	-	270	245	-	62
7001	A	-	305	216	57	65
	B	-	380	245	64	65
7002	A	-	305	-	57	3
	B	-	380	-	64	3

custom sized Plates available upon request

Pull Handles & Finger Plates

A traditional offset design Pull, with or without Back Plate, and a matching Finger Plate, both offered in two sizes. The Pulls are also offered in pairs for back-to-back installation.

These Pulls can be fitted to a variety of different Back Plates if desired.



Fixings

6999 & 7000 supplied with M6 x 50mm machine screws (longer screws available upon request).

7000 also supplied with finish matched no.8 x 25mm wood screws.

Back-to-back fixed pairs supplied with M6 'beefeater' fixing system to suit doors up to 64mm thick.

6998 supplied with finish matched no.6 x 19mm wood screws.

How to Order

- 1) select HANDLE/PLATE (e.g. **7000**)
- 2) add FINISH (e.g. **7000PB**)
- 3) add SIZE (e.g. **7000PB/A**).

6999 & 7000 - to order a pair of Handles with BACK-TO-BACK fixing add BTB (e.g. **6999PB/B/BTB**).

NB. When fitting a BTB pair of Handles to an EXTERIOR door it is important the grubscrew fixing is on the internal face - please contact us for coding instructions.

For Pulls fitted to different Back Plates - please contact us to discuss available options.

Finishes - See our price list or website for finish availability.



▲ **7000**

▲ **6999**
(rear bolt fixing)

▲ **6998**

			Overall length	Centres	Plate width	Projection
6998	A	-	305	-	57	8
	B	-	380	-	64	8
6999	A	-	240	216	-	62
	B	-	270	245	-	62
7000	A	-	305	216	57	70
	B	-	380	245	64	70

Pull Handles & Finger Plates

A traditional offset design Pull, with or without Back Plate, and matching Finger Plate, offered in two sizes. Pulls in pairs for back-to-back installation are available.

The Back Plate & Finger Plate, manufactured from 3mm thick material, are also available in custom lengths.

The Pulls can be fitted to a variety of different Back Plates if desired.

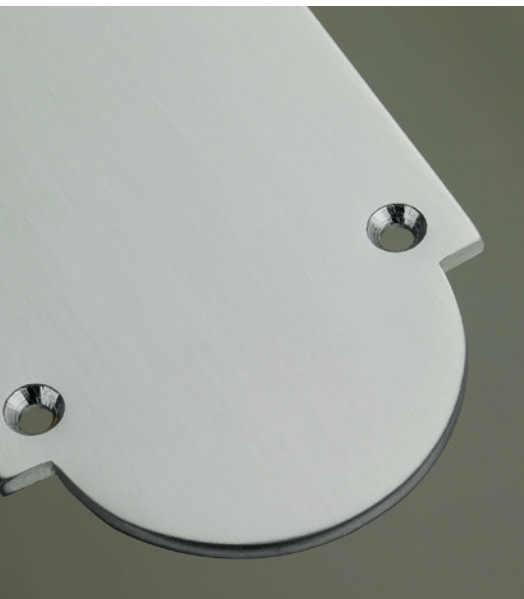

Fixings

1976 & 1979 supplied with M6 x 50mm machine screws (longer screws available upon request).

1979 also supplied with finish matched no.8 x 25mm wood screws.

Back-to-back fixed pairs supplied with M6 'beefeater' fixing system to suit doors up to 64mm thick.

1980 supplied with finish matched no.6 x 19mm wood screws.

How to Order

1) select HANDLE/PLATE (e.g. **1979**)

2) add FINISH (e.g. 1979**PB**)

3) add SIZE (e.g. 1979PB/**A**).

1976 & 1979 - to order a pair of Handles with BACK-TO-BACK fixing add BTB (e.g. 1979PB/B/**BTB**).

NB. When fitting a BTB pair of Handles to an EXTERIOR door it is important the grub screw fixing is on the internal face - please contact us for coding instructions.

For Pulls fitted to different Back Plates - please contact us to discuss available options.

Finishes - See our price list or website for finish availability.



▲ 1979

▲ 1976
(rear bolt fixing)

▲ 1980

		Overall length	Centres	Plate width	Projection
1976	A	255	218	-	62
	B	287	250	-	62
1979	A	350	218	64	65
	B	400	250	64	65
1980	A	350	-	64	3
	B	400	-	64	3

Pull Handles & Finger Plates

A traditional offset design Pull with Back Plate, and a matching Finger Plate, both offered in two sizes. The Pulls are also offered in pairs for back-to-back installation.

The Pull can be fitted to a variety of different Back Plates if desired.



Fixings

1977 supplied with M6 x 50mm machine screws (longer screws available upon request) and finish matched no.8 x 25mm wood screws.

Back-to-back fixed pairs supplied with M6 'beefeater' fixing system to suit doors up to 64mm thick.

1975 supplied with finish matched no.6 x 19mm wood screws.

How to Order

- 1) select HANDLE/PLATE (e.g. 1977)
- 2) add FINISH (e.g. 1977PB)
- 3) add SIZE (e.g. 1977PB/A).

1977 - to order a pair of Handles with BACK-TO-BACK fixing add BTB (e.g. 1977PB/B/BTB).

NB. When fitting a BTB pair of Handles to an EXTERIOR door it is important the grub screw fixing is on the internal face - please contact us for coding instructions.

For Pulls fitted to different Back Plates - please contact us to discuss available options.

Finishes - See our price list or website for finish availability.



▲ 1977



▲ 1975

Products discontinued – please contact us to discuss alternative options

		Overall length	Centres	Plate width	Projection
1975	A	305	-	57	6
	B	380	-	64	6
1977	A	305	218	57	65
	B	380	250	64	65

Pull Handles & Finger Plates

An Art Deco period offset design Pull, with or without Back Plate, and a matching Finger Plate.

This design of Pull is not available with a back-to-back installation option.

The Pulls can be fitted to a variety of different Back Plates if desired.



Fixings

9531 & 9533 supplied with M6 x 50mm machine screws (longer screws available upon request).

9533 also supplied with finish matched no.8 x 25mm wood screws.

9541 supplied with finish matched no.6 x 19mm wood screws.

How to Order

9531 & 9533:

- 1) select HANDLE (e.g. **9533**)
- 2) add FINISH (e.g. 9533**PB**)
- 3) add HANDING (e.g. 9533**PB/LH**)

9541:

- 1) select FINISH (e.g. **9541PB**)
- 2) add SIZE (e.g. 9541**PB/A**)

NB. This handle design is not available with a back-to-back fixing option.

For Pulls fitted to different Back Plates - please contact us to discuss available options.

Finishes - See our price list or website for finish availability.



▲ **9533**

RH shown

▲ **9531**
(rear bolt fixing)

RH shown

▲ **9541**

		Overall length	Centres	Plate width	Projection
9531		303	190	-	55
9533		350	190	63	60
9541	A	300	-	63	5
	B	350	-	63	5

Pull Handles

An Art Deco period offset Pull, with or without Back Plate, or with face fixed Pad Plates, along with a matching Finger Plate - all offered in two sizes.

The Pulls are also offered in pairs for back-to-back installation, and can be fitted to a variety of different Back Plates if desired.

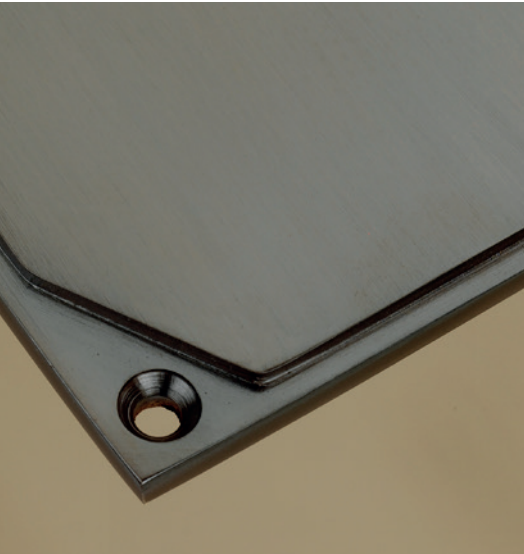

Fixings

9512, 9515 & 9516 supplied with M6 x 50mm machine screws (longer screws available upon request).

9513 supplied with finish matched no.6 x 19mm wood screws and M6 x 50mm machine screws (longer screws available upon request).

9514 supplied with finish matched no.6 x 19mm wood screws.

9516 also supplied with finish matched no.8 x 25mm wood screws.

Back-to-back fixed pairs supplied with M6 'beefeater' fixing system to suit doors up to 64mm thick.

How to Order

- 1) select HANDLE/PLATE (e.g. **9516**)
- 2) add FINISH (e.g. 9516**PB**)
- 3) add SIZE (e.g. 9516**PB/A**).

To order a pair of Handles with BACK-TO-BACK fixing add BTB (e.g. 9516**PB/A/BTB**).

NB. When fitting a BTB pair of Handles to an EXTERIOR door it is important the grubscrew fixing is on the internal face - please contact us for coding instructions.

For Pulls fitted to different Back Plates - please contact us to discuss available options.

Finishes - See our price list or website for finish availability.



▲ **9516**



▲ **9512** (rear bolt fixing)



▲ **9513** (face fixed & rear bolt fixed)
9514 (face fixed only)
9515 (rear bolt fixed only - no screw holes)

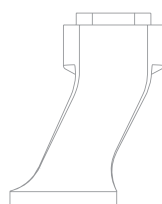

offset design

		Overall length	Centres	Plate size	Projection
9512	A	210	190	-	40
	B	254	230	-	46
9513-5	A	240	190	50 x 38	45
	B	280	230	50 x 38	51
9516	A	300	190	300 x 63	46
	B	350	230	350 x 63	52

Pull Handles

A traditional offset design Pull, available in two lengths and with eight Rosette designs, each in four diameters, which complement the Allart Select Door Knob & Lever Rosettes (see section ST3).



Fixings

Supplied with M6 x 50mm machine screws (longer screws available upon request).

Back-to-back fixed pairs supplied with M6 'beefeater' fixing system to suit doors up to 64mm thick.

How to Order

- 1) select HANDLE (e.g. **1986**)
- 2) add FINISH (e.g. 1986**PC**)
- 3) add LENGTH (e.g. 1986PC/**A**)
- 4) add ROSETTE SIZE (e.g. 1986PC/**A44**).

To order a pair of Handles with BACK-TO-BACK fixing add BTB (e.g. 1986PC/A44/**BTB**).

NB. When fitting a BTB pair of Handles to an EXTERIOR door it is important the grub screw fixing is on the internal face - please contact us for coding instructions.

Finishes - See our price list or website for finish availability.



size A shown with 44mm Ø rosettes

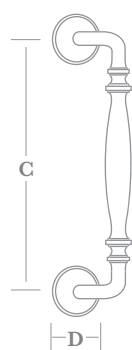

	C (centres)	Projection	D (diameter)
A	218	60	Ø 38, 44, 54, 64
B	250	60	Ø 38, 44, 54, 64

Pull Handles

A traditional straight design Pull, available in two lengths and with eight Rosette designs, which complement the Allart Select Door Knob & Lever Rosettes (see section ST3).

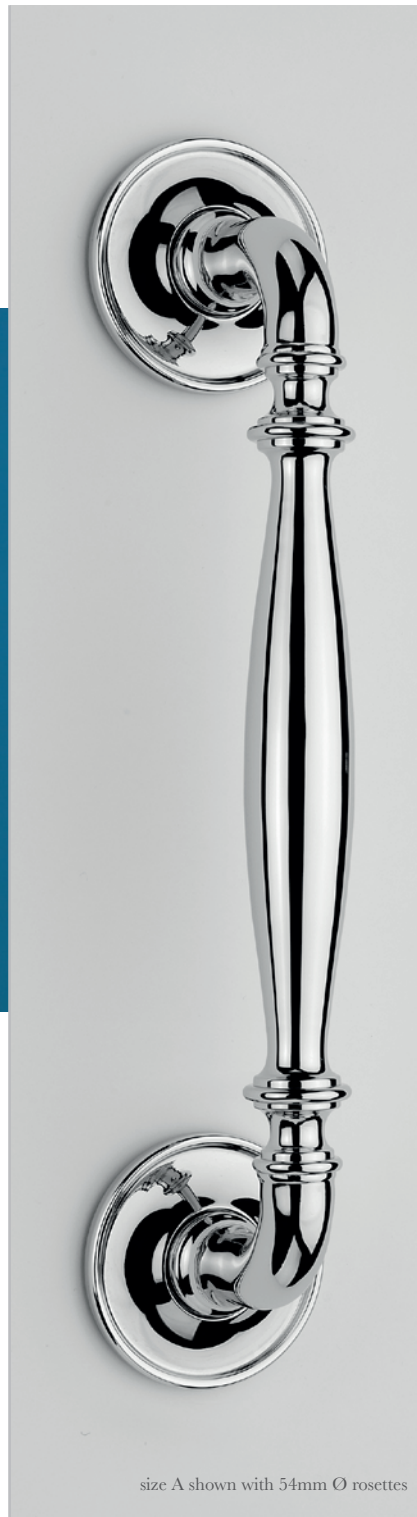

size A shown with 54mm Ø rosettes



Fixings

Supplied with M6 x 50mm machine screws (longer screws available upon request).

Back-to-back fixed pairs supplied with M6 'beefeater' fixing system to suit doors up to 64mm thick.

How to Order

- 1) select HANDLE (e.g. 1911)
- 2) add FINISH (e.g. 1911PC)
- 3) add LENGTH (e.g. 1911PC/A)
- 4) add ROSETTE SIZE (e.g. 1911PC/A44).

To order a pair of Handles with BACK-TO-BACK fixing add BTB (e.g. 1911PC/A44/BTB).

Finishes - See our price list or website for finish availability.

▲ 1911

▲ 1916

▲ 1917

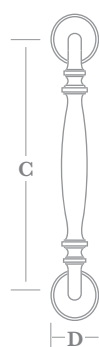

	C (centres)	Projection	D (diameter)
A	209	56	Ø 38, 44, 54, 64
B	241	56	Ø 38, 44, 54, 64

Pull Handles

A classic straight design Pull, available in three lengths and with twelve Rosette designs, each in up to three diameters, which complement the Allart Select Door Knob & Lever Rosettes (see section ST3).



▲ 4359

size B shown with 54mm Ø rosettes



Fixings

Supplied with M8 x 50mm machine screws (longer screws available upon request).

Back-to-back fixed pairs supplied with M8 'beefeater' fixing system to suit doors up to 64mm thick.

How to Order

- 1) select HANDLE (e.g. 4358)
- 2) add FINISH (e.g. 4358PC)
- 3) add LENGTH (e.g. 4358PC/A)
- 4) add ROSETTE SIZE (e.g. 4358PC/A38).

To order a pair of Handles with BACK-TO-BACK fixing add BTB (e.g. 4358PC/A38/BTB).

Finishes - See our price list or website for finish availability.

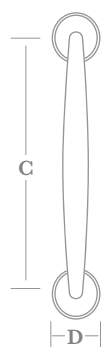

	C (centres)	Projection	D (diameter)
A	175	54	Ø 38
B	226	61	Ø 44, 54, 64
C	310	73	Ø 44, 54, 64

Pull Handles & Finger Plates

A traditional period straight design Pull, with or without Back Plate, and a matching Finger Plate. The Pulls are also offered in pairs for back-to-back installation.

The Pulls can be fitted to a variety of different Back Plates if desired.



Fixings

3934 & 3938 supplied with M6 x 50mm machine screws (longer screws available upon request).

3938 also supplied with finish matched no.8 x 25mm wood screws.

Back-to-back fixed pairs supplied with M6 'beefeater' fixing system to suit doors up to 64mm thick.

3940 supplied with finish matched no.6 x 19mm wood screws.

How to Order

1) select HANDLE/PLATE (e.g. **3938**)

2) add FINISH (e.g. 3938**PB**)

3934 & 3938 - to order a pair of Handles with BACK-TO-BACK fixing add BTB (e.g. 3934**PB/BTB**).

For Pulls fitted to different Back Plates - please contact us to discuss available options.

Finishes - See our price list or website for finish availability.



▲ 3938



▲ 3934
(rear bolt fixing)

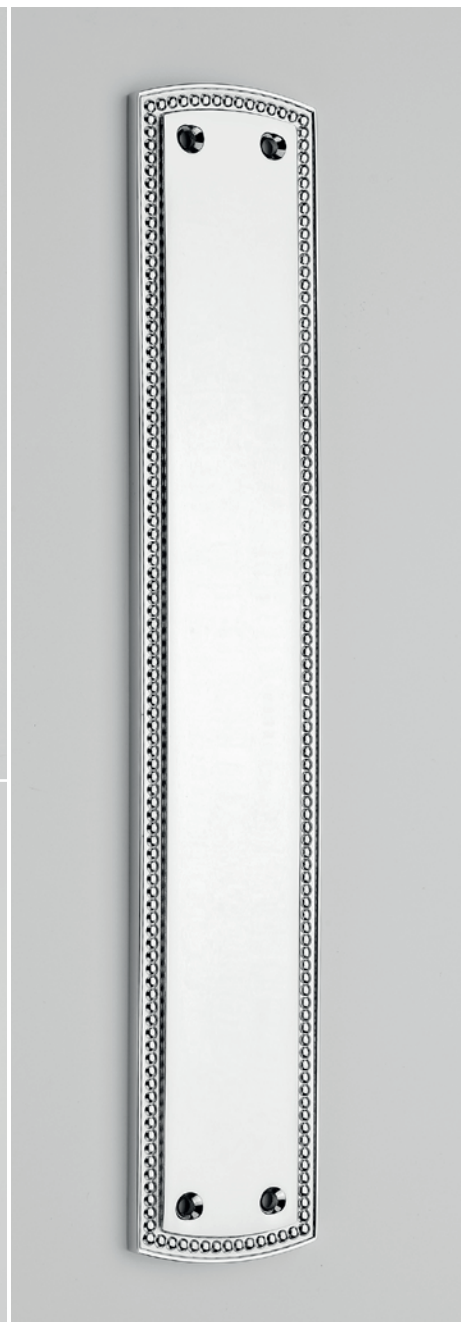

▲ 3940

	Overall length	Centres	Plate width	Projection
3934	245	159	-	58
3938	280	159	50	56
3940	280	-	50	6

Finger Plates

A selection of Finger Plates / Pull Handle Back Plates in eleven standard sizes. Custom sizes are available upon request.

Pull Handle Back Plates are machined to mount the chosen Pull Handle centrally on the Plate.

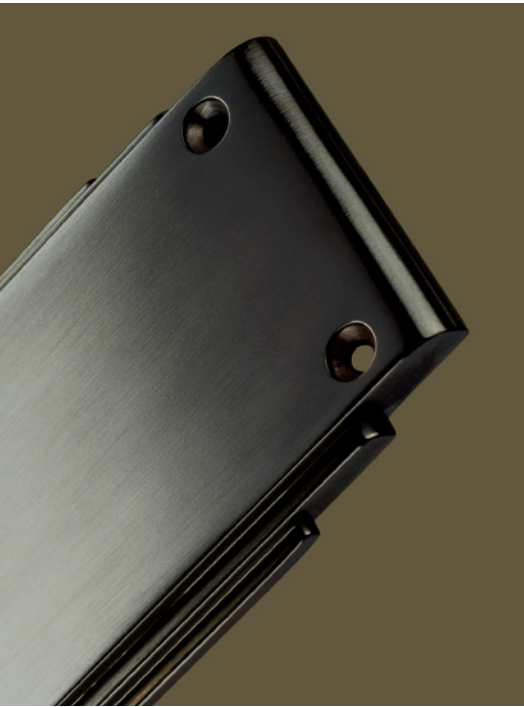

Fixings

Supplied with finish matched no.6 x 19mm wood screws.

How to Order

Finger Plates:

- 1) select PLATE (e.g. **6680**)
- 2) add SIZE (e.g. **6680B**).
- 3) add FINISH (e.g. **6680B/PC**).

Back Plate with Pull Handle:

- 1) select PLATE (e.g. **6680**)
- 2) add SIZE (e.g. **6680B**)
- 3) add PULL HANDLE CODE & SIZE (e.g. **6680B/4325B**)
- 4) add FINISH (e.g. **6680B/4325B/PC**)

Finishes - See our price list or website for finish availability.



A size shown

▲ **6880**

PLATE DESIGNS (54mm width shown)

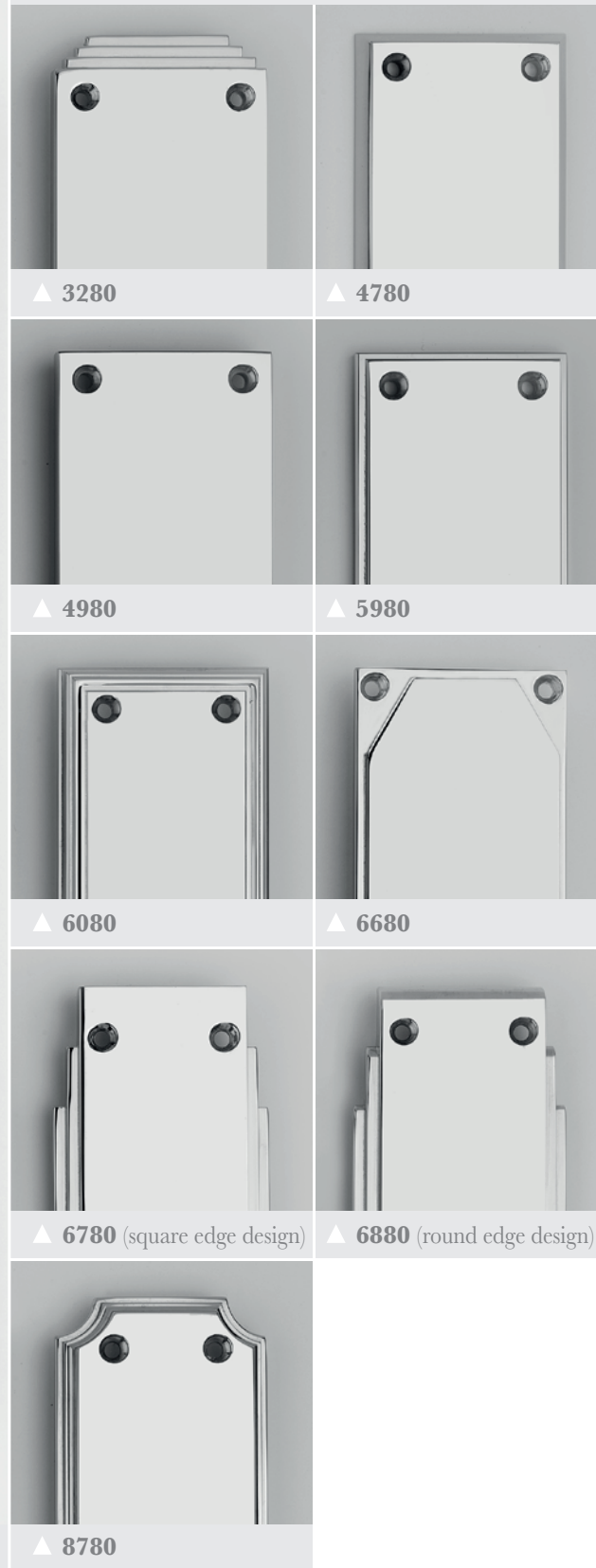

	AA	A	B	C	D	E	F	G	H	J	K
Length	254	254	254	305	305	380	380	380	406	406	406
Width	54	64	76	64	76	64	76	89	76	89	102
Thickness	all plates are 6mm thick										

Custom sizes available upon request - surcharge may apply.

Finger Plates - Concealed Fix

A selection of concealed adhesive fix Finger Plates in eleven standard sizes. Custom sizes are available upon request.



Fixings

Supplied with four locating fixing pins to the rear for adhesive fixing.

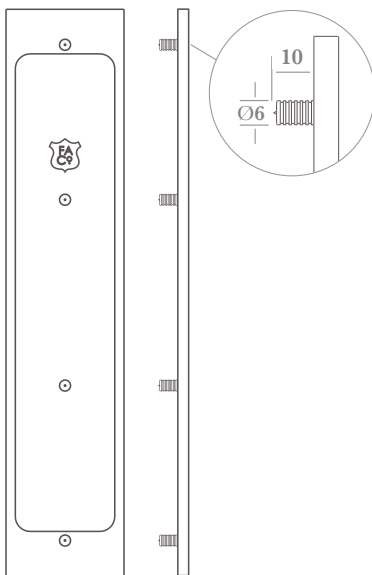

Rear view

How to Order

Finger Plates:

- 1) select PLATE (e.g. **6830**)
- 2) add SIZE (e.g. **6830B**).
- 3) add FINISH (e.g. **6830B/PC**).

Finishes - See our price list or website for finish availability.



▲ **6730**



PLATE DESIGNS (54mm width shown)

▲ **3230**

▲ **4730**

▲ **4930**

▲ **5930**

▲ **6030**

▲ **6630**

▲ **6730** (square edge design)

▲ **6830** (round edge design)

▲ **8730**

	AA	A	B	C	D	E	F	G	H	J	K
Length	254	254	254	305	305	380	380	380	406	406	406
Width	54	64	76	64	76	64	76	89	76	89	102
Thickness	all plates are 6mm thick										

Custom sizes available upon request - surcharge may apply.

Finger Plates & Kick Plates

Finger Plates and Kick Plates manufactured from sheet metal of three different thicknesses, made to order in custom sizes and with the option of either square or rounded corners.



Fixings

Supplied with finished matched no.6 x 19mm wood screws.

Kick Plates and large Finger Plates will be supplied with either 6 or 8 screws as appropriate.

How to Order

- 1) select PLATE (e.g. **2295**)
- 2) add FINISH (e.g. **2295PC**)
- 3) add SIZE & THICKNESS (*)
(e.g. **2295PC850X150X1.6**).

(*) available in three thicknesses:
1.6mm, 2mm, 3mm

Finishes - See our price list or website for finish availability.

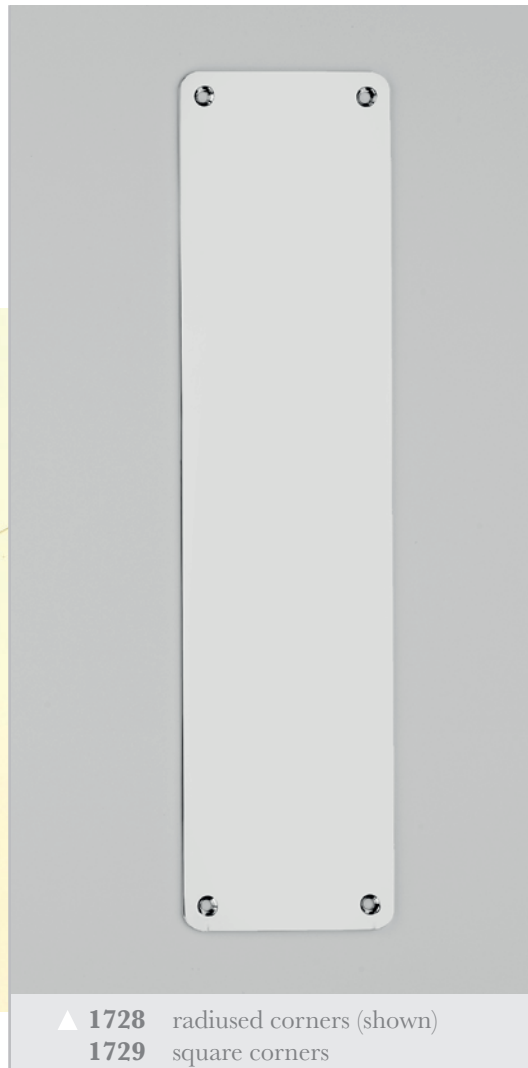

▲ **1728** radiused corners (shown)
1729 square corners



▲ **2294** radiused corners
2295 square corners (shown)