

Interchangeable Cabinet Knob & Rose Combinations

Our Cabinet Knobs are now offered in a choice of different Rosette combinations to provide complete design flexibility. This also affords the specifier the opportunity to mix finishes between Knob and Rosette to create a truly unique and individual piece.



0610 Polished Silver Knob on 0667ROSE in Antique Silver



	A	B	C	D
Diameter (all Rosettes except 0631)	Ø 19	Ø 25	Ø 32	Ø 38
0631 Diameter	Ø 25	Ø 32	Ø 38	-

How to Order

The Cabinet Knob and Rosette are ordered separately. Rosette codes are shown opposite, Cabinet Knob codes are shown throughout this section. Order the Rosette as follows:

- 1) select ROSETTE (e.g. 0645ROSE)
- 2) add FINISH (e.g. 0645ROSE/**PB**)
- 3) add SIZE (e.g. 0645ROSE/**PB/B**).

When ordering the Cabinet Knob, use Knob only code (eg. 0644, not 0645).

IMPORTANT - Please note that the Cabinet Knob and Rosette sizes must be the same (ie. a 32mm Cabinet Knob cannot be paired with a 25mm Rosette).

Finishes - See our price list or website for finish availability.

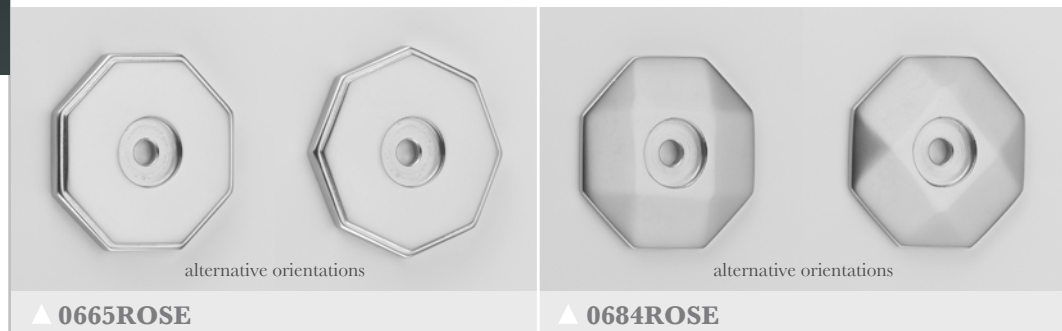

	A	B	C
Size (A/F)	25	32	38

A/F = dimension across flats

EXAMPLE

0644 Cabinet Knob shown with a selection of alternative Rosette combinations.

Cabinet Knobs

Four Cabinet Knob designs - in Smooth, Linear, Diamond and Square Mesh textures, each available in three sizes, with or without Rosette. Each knob & rosette is precision CNC machined for accuracy and consistent fine detailing. Designed to complement matching Allart Select Door Knobs in section ST2.



Fixings

Supplied with M4 x 50mm break-off flange head machine screws.



Dowel Screw option available

How to Order

- 1) select KNOB (e.g. **0701**)
 - 2) add FINISH (e.g. 0701**PB**)
 - 3) add SIZE (e.g. 0701**PB/B**).
- Choose DOWEL SCREW option if required (e.g. 0701**PB/B/DS**).

Finishes - See our price list or website for finish availability.



approx actual size B

▲ 0701



approx actual size B

▲ 0700



approx actual size B

▲ 0703



approx actual size B

▲ 0702



approx actual size B

▲ 0705



approx actual size B

▲ 0704



approx actual size B

▲ 0707



approx actual size B

▲ 0706

	A	B	C
D (diameter)	Ø 25	Ø 32	Ø 38
P (projection)	26	33	39
<i>p</i> (projection)	25	32	38

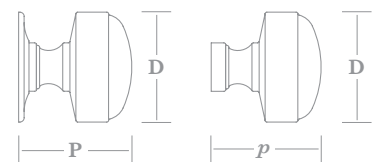

Cabinet Knobs

Two classic Cabinet Knobs, available in four sizes with or without Rosette, designed to complement both Allart Select and Traditional Door Knobs (see sections ST2 and DF2). Each knob & rosette is precision CNC machined for accuracy and consistent fine detailing.



▲ 0640



▲ 0641

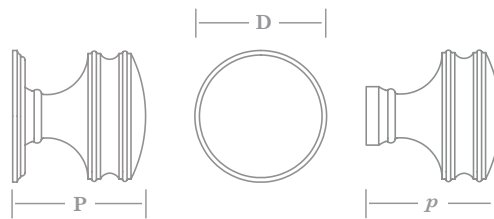

	A	B	C	D
D (dia)	Ø 19	Ø 25	Ø 32	Ø 38
p (proj)	19	24	31	36
P (proj)	20	25	32	37



▲ 0642



▲ 0643

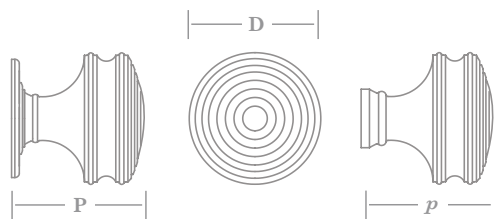

	A	B	C	D
D (dia)	Ø 19	Ø 25	Ø 32	Ø 38
p (proj)	19	24	31	36
P (proj)	20	26	33	37

Fixings

Supplied with M4 x 50mm break-off flange head machine screws.



How to Order

- 1) select KNOB (e.g. 0642)
- 2) add FINISH (e.g. 0642PB)
- 3) add SIZE (e.g. 0642PB/B).

Choose DOWEL SCREW option if required (e.g. 0642PB/B/DS).

Finishes - See our price list or website for finish availability.

Cabinet Knobs

Two traditional Cabinet Knobs, available in four sizes with or without Rosette, designed to complement both Allart Select and Traditional Door Knobs (see sections ST2 and DF2).

Each knob & rosette is precision CNC machined for accuracy and consistent fine detailing.



▲ 0644



▲ 0645

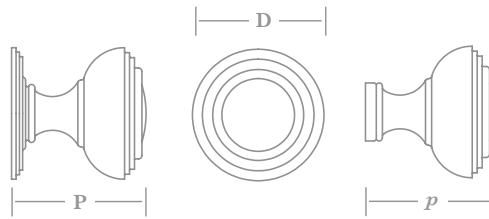

	A	B	C	D
D (dia)	Ø 19	Ø 25	Ø 32	Ø 38
p (proj)	19	24	31	36
P (proj)	20	26	33	37

Fixings

Supplied with M4 x 50mm break-off flange head machine screws.



How to Order

- 1) select KNOB (e.g. **0644**)
- 2) add FINISH (e.g. 0644**PB**)
- 3) add SIZE (e.g. 0644PB/**B**).

Choose DOWEL SCREW option if required (e.g. 0644PB/B/**DS**).

Finishes - See our price list or website for finish availability.



▲ 0646



▲ 0647

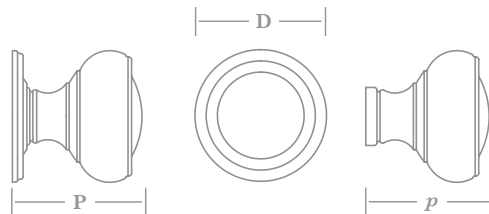

	A	B	C	D
D (dia)	Ø 19	Ø 25	Ø 32	Ø 38
p (proj)	19	24	30	36
P (proj)	20	26	31	37

Cabinet Knobs

Four contemporary Cabinet Knobs, each available in three sizes with or without Rosette. Each knob & rosette is precision CNC machined for accuracy and consistent fine detailing.



Fixings

Supplied with M4 x 50mm break-off flange head machine screws.



How to Order

- 1) select KNOB (e.g. **0631**)
 - 2) add FINISH (e.g. 0631**PB**)
 - 3) add SIZE (e.g. 0631**PB/B**).
- Choose DOWEL SCREW option if required (e.g. 0631**PB/B/DS**).

Finishes - See our price list or website for finish availability.



	A	B	C
D (diameter)	Ø 25	Ø 32	Ø 38
P (projection)	25	32	37
<i>p</i> (projection)	24	31	36

Cabinet Knobs

A selection of Cabinet Knobs available in various sizes, all designed to complement both Allart Select and Traditional Door Knobs (see sections ST2 and DF2).

Each knob & rosette is precision CNC machined for accuracy and consistent fine detailing.



approx actual size

▲ **0686** Ø 29 x 23 projection



approx actual size

▲ **0687** Ø 29 x 27 projection (rosette 32 Ø)



approx actual size D

▲ **0677**



approx actual size D

▲ **0678**



approx actual size C

▲ **0680**



approx actual size C

▲ **0685**

Fixings

Supplied with M4 x 50mm break-off flange head machine screws.



Dowel Screw option available

How to Order

- 1) select KNOB (e.g. **0680**)
- 2) add FINISH (e.g. 0680**PB**)
- 3) add SIZE (except 0686-7) (e.g. 0680**PB/B**).

Choose DOWEL SCREW option if required (e.g. 0680**PB/B/DS**).

Finishes - See our price list or website for finish availability.

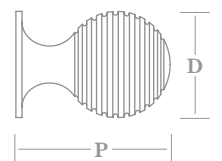
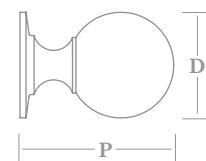
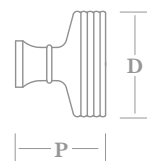
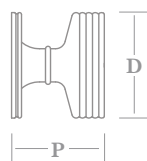

		A	B	C	D	E
	D (diameter)	Ø 19	Ø 25	Ø 32	Ø 38	Ø 44
0680/0685	P (projection)	27	37	46	55	64
0677	P (projection)	17	23	27	32	-
0678	P (projection)	18	24	28	33	-

Cabinet Knobs

Four Cabinet Knob designs, each available in four sizes with or without Rosette, which complement both Allart Select and Traditional Door Knobs (see sections ST2 and DF2). Each knob & rosette is precision CNC machined for accuracy and consistent fine detailing.



Fixings

Supplied with M4 x 50mm break-off flange head machine screws.



How to Order

- 1) select KNOB (e.g. **9176**)
 - 2) add FINISH (e.g. 9176**PB**)
 - 3) add SIZE (e.g. 9176PB/**B**).
- Choose DOWEL SCREW option if required (e.g. 9176PB/B/**DS**).

Finishes - See our price list or website for finish availability.



▲ 9176



▲ 9174



▲ 9177



▲ 9171



▲ 9178



▲ 9172



▲ 9179 (not available in size A)



▲ 9173 (not available in size A)

	A	B	C	D
D (diameter)	Ø 16	Ø 25	Ø 32	Ø 38
P (projection)	16	25	32	38
<i>p</i> (projection)	14	23	28	34



Cabinet Knobs

Three classic Cabinet Knobs, each available in four sizes with or without Rosette, designed to complement both Allart Select and Traditional Door Knobs (see sections ST2 and DF2). Each knob & rosette is precision CNC machined for accuracy and consistent fine detailing.



▲ 0693



▲ 0692



▲ 0695



▲ 0694



▲ 0697



▲ 0696

Fixings

Supplied with M4 x 50mm break-off flange head machine screws.



Dowel Screw option available

How to Order

- 1) select KNOB (e.g. **0697**)
 - 2) add FINISH (e.g. 0697**PB**)
 - 3) add SIZE (e.g. 0697PB/**B**).
- Choose DOWEL SCREW option if required (e.g. 0697PB/**B/DS**).

Finishes - See our price list or website for finish availability.

0692-0697	A	B	C	D
D (diameter)	Ø 19	Ø 25	Ø 32	Ø 38
P (projection)	20	24	30	36
<i>p</i> (projection)	19	23	29	35

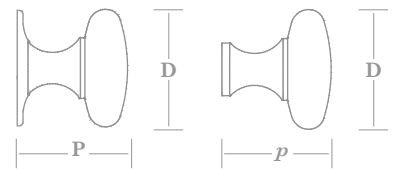

Cabinet Knobs

A selection of Art Deco period Cabinet Knobs, all produced from hot brass stampings. Available in various sizes, designed to complement both Allart Select and Traditional Door Knobs (see sections ST2 and DF2).



▲ 9598



▲ 9596

	Knob size	Plate size	P (projection)
9596 A	32 x 16	-	25
B	38 x 19	-	27
9598	38 x 19	40 x 20	30

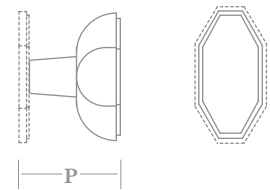

▲ 9590



▲ 9591



▲ 9592



▲ 9593

		Knob size	Plate size	P (projection)
9590 A	9592 A	19 x 12	Ø 19	17
B	B	25 x 16	Ø 25	22
C	C	32 x 20	Ø 32	28
D	D	38 x 24	Ø 38	33
9591 A	9593 A	19 x 12	-	16
B	B	25 x 16	-	21
C	C	32 x 20	-	27
D	D	38 x 24	-	32

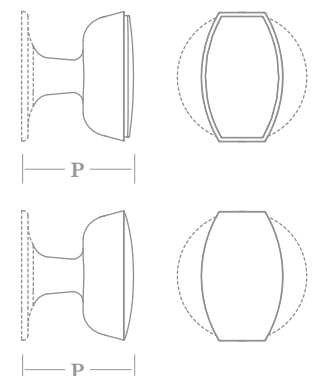

Fixings

Supplied with M4 x 50mm break-off flange head machine screws.



Dowel Screw option available

How to Order

- 1) select KNOB (e.g. 9596)
 - 2) add FINISH (e.g. 9596PC)
 - 3) add SIZE (except 9598) e.g. 9596PC/B.
- Choose DOWEL SCREW option if required (e.g. 9596PC/B/DS).

Finishes - See our price list or website for finish availability.

Cabinet Knobs

A selection of Cabinet Knobs available in various sizes, all designed to complement both Allart Select and Traditional Door Knobs (see sections ST2 and DF2).



▲ 0698



▲ 0699

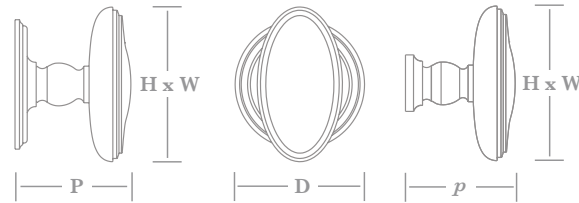

0698-9	A	B
H x W	30 x 16	38 x 21
D (dia)	Ø 25	Ø 32
p (proj)	23	28
P (proj)	24	29



▲ 0666



▲ 0667

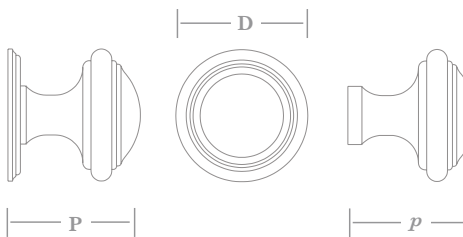

0666-7	A	B	C	D
D (dia)	Ø 19	Ø 25	Ø 32	Ø 38
p (proj)	19	24	31	38
P (proj)	20	25	32	39

Fixings

Supplied with M4 x 50mm break-off flange head machine screws.



Dowel Screw option available

How to Order

- 1) select KNOB (e.g. **0698**)
- 2) add FINISH (e.g. 0698**PB**)
- 3) add SIZE (e.g. 0698PB/**B**).

Choose DOWEL SCREW option if required (e.g. 0698PB/B/**DS**).

Finishes - See our price list or website for finish availability.



▲ 0664



▲ 0665

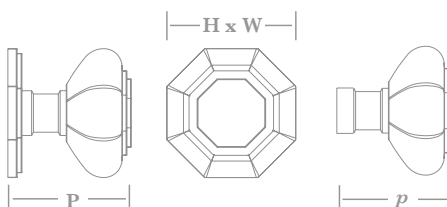

0664-5	A	B	C
H x W	25 x 25	32 x 32	38 x 38
p (proj)	23	29	35
P (proj)	24	31	37

Cabinet Knobs

A selection of contemporary Cabinet Knobs available in various sizes, designed to complement Allart Select Door Knobs (see section ST2).

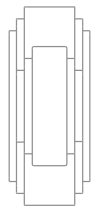
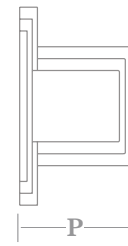
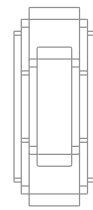
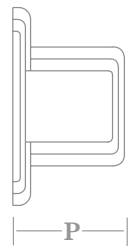
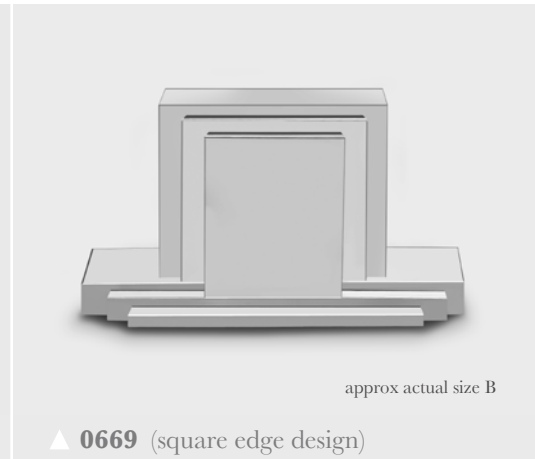
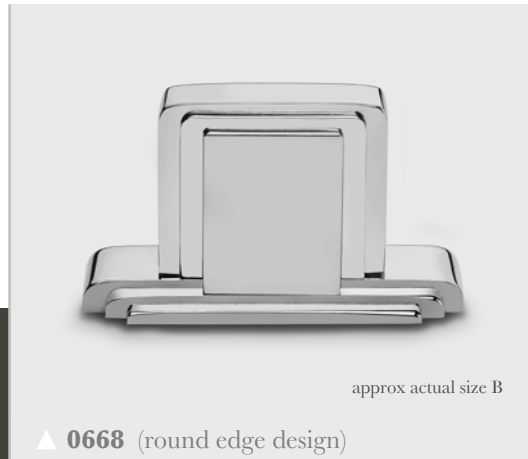
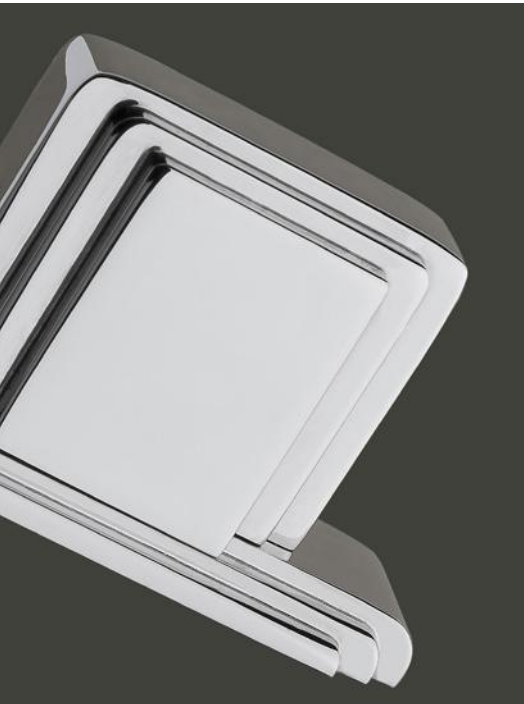

0668/9	Knob	Plate	P (proj)
A	25 x 13	40 x 16	24
B	30 x 17	50 x 21	28
C	37 x 19	60 x 23	34

Fixings

Supplied with M4 x 50mm break-off flange head machine screws.



How to Order

- 1) select KNOB (e.g. **0668**)
- 2) add FINISH (e.g. 0668**PB**)
- 3) add SIZE (e.g. 0668PB/**B**).

Choose DOWEL SCREW option if required (e.g. 0668PB/B/**DS**).

Finishes - See our price list or website for finish availability.

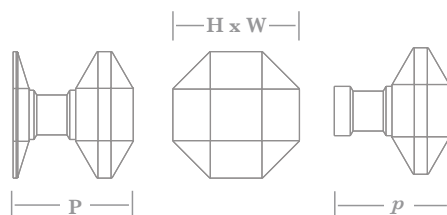
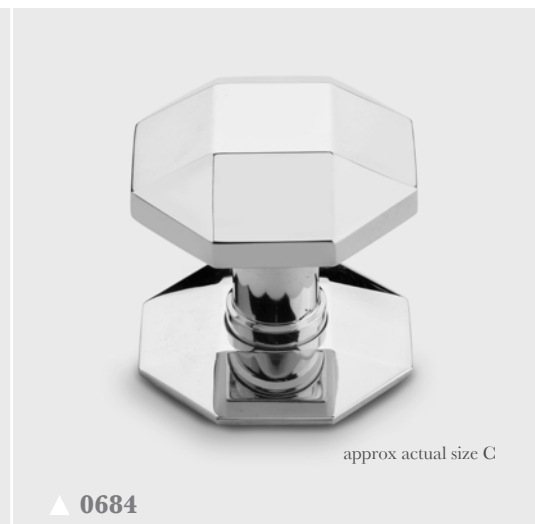

0683-4	A	B	C
H x W	25 x 25	32 x 32	38 x 38
p (proj)	21	27	33
P (proj)	23	29	35

Cabinet Knobs

A selection of contemporary Cabinet Knobs available in various sizes, designed to complement Allart Select Door Knobs (see section ST2).

The 0671 & 0672 are produced from hot brass stampings, whilst the other knobs are fully CNC machined.



approx actual size

▲ 0671



approx actual size

▲ 0672



approx actual size B

▲ 0675 (round edge design)



approx actual size B

▲ 0676 (square edge design)



approx actual size C

▲ 0690



approx actual size C

▲ 0691

Fixings

0671 & 0672 supplied with M6 x 40mm pan head machine screws. All others supplied with M4 x 50mm break-off flange head machine screws.



Dowel Screw option available

How to Order

- 1) select KNOB (e.g. 0671)
- 2) add FINISH (e.g. 0671PB)
- 3) add SIZE (except 0671-2) (e.g. 0690PB/B).

Choose DOWEL SCREW option if required (e.g. 0690PB/B/DS).



approx actual size C

▲ 0689

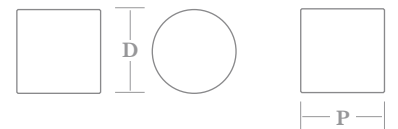

0689 / 0690 / 0691

0689/0690/0691	A	B	C	D
D (depth/diameter)	19	25	32	38
P (projection)	19	25	32	38

Finishes - See our price list or website for finish availability.

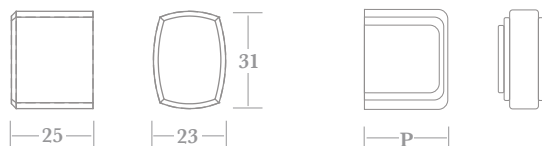

0671 / 0672

0675 / 0676

0675/6	Knob size	P (projection)
A	25 x 13	21
B	30 x 17	25
C	37 x 19	31

Cabinet Knobs - 32mm

Two Cabinet Knobs, Oval and Domed Oval designs, each available fitted to seven different 32mm diameter Rosettes which complement the Allart Select Door Knob & Lever Rosettes (see section ST3).

7210 Hand Burnished Brass Oval Knob on 7216ROSE Antique Brass Rosette



▲ 32mm Cabinet Knob (oval design)



Fixings

Supplied with M4 x 50mm break-off flange head machine screws.



How to Order

- 1) select KNOB (e.g. 7222)
 - 2) add FINISH (e.g. 7222PC).
- Choose DOWEL SCREW option if required (e.g. 7222PC/DS).

Finishes - See our price list or website for finish availability.



▲ 32mm Cabinet Knob (domed oval design)

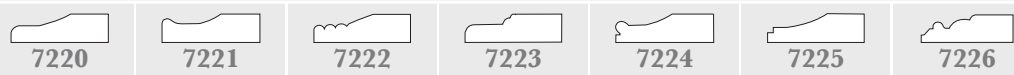

Cabinet Knobs - 38mm

Two Cabinet Knobs, Oval and Domed Oval designs, each available fitted to seven different 38mm diameter Rosettes which complement the Allart Select Door Knob & Lever Rosettes (see section ST3).

7240 Oval Knob on 7242ROSE Rosette



▲ 38mm Cabinet Knob (oval design)

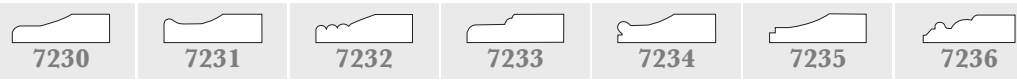

Fixings

Supplied with M4 x 50mm break-off flange head machine screws.



How to Order

- 1) select KNOB (e.g. 7232)
 - 2) add FINISH (e.g. 7232PC).
- Choose DOWEL SCREW option if required (e.g. 7232PC/DS).

Finishes - See our price list or website for finish availability.



▲ 38mm Cabinet Knob (domed oval design)

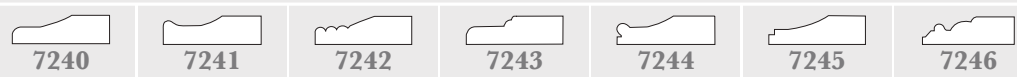

Cabinet Knobs

A selection of traditional Cabinet Knobs available in various sizes, all designed to complement both Allart Select and Traditional Door Knobs (see sections ST2 and DF2).

The 0670 & 0674 are fully CNC machined, whilst the other Oval and Domed Oval knobs are produced from hot brass stampings.



	A	B	C	D
D (diameter)	Ø 19	Ø 25	Ø 32	Ø 38
P (projection)	19	25	32	38

▲ 0670



	A	B	C
D (diameter)	Ø 25	Ø 32	Ø 38
P (projection)	25	32	38

▲ 0674



	A	B
H x W (height x width)	32 x 21	38 x 24
P (projection)	31	35

▲ 0681

▲ 0682



	A	B
H x W (height x width)	32 x 22	38 x 27
P (projection)	31	37
9169 plate size	38 x 38 x 4	38 x 38 x 4

▲ 9169

▲ 9168

Fixings

All except 0681 supplied with M4 x 50mm break-off flange head machine screws.



0681A supplied with finish matched no.4 x 13mm wood screws.

0681B supplied with finish matched no.6 x 19mm wood screws.

How to Order

- 1) select KNOB (e.g. **0682**)
- 2) add FINISH (e.g. 0682**PB**)
- 3) add SIZE (e.g. 0682PB/**B**).

Choose DOWEL SCREW option if required (e.g. 0682PB/B/**DS**).

Finishes - See our price list or website for finish availability.