

Door Knobs

Two contemporary Door Knobs - in smooth and linear textures, both available in four sizes - designed to work in conjunction with the Rosettes & Backplates to be found in sections ST3 & ST4. Matching Cabinet Knobs are available, see section CF1.



▲ 7679

approx actual size B



▲ 7679B with 7821B rosette

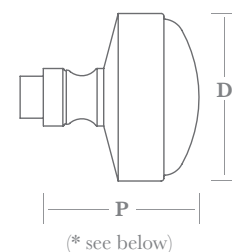

▲ 7680

approx actual size B



▲ 7680B with 7821B rosette

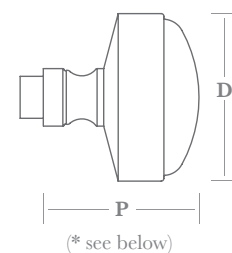

Fixings

Supplied with 8mm x 110mm stainless steel lockpoint spindle and M6 grub screw (64mm max. door thickness); alternative spindle lengths and functions are available - see pages ST6:070 & 080.

Installation instructions supplied.

How to Order

Split Finish Sets - order as singles

1) select KNOB (e.g. 7679)

PLEASE NOTE: To work with Sprung Rosettes, the Knob needs to be machined to fit and 'SPG' must be added to the code eg. 7679SPG/...

2) add FINISH (e.g. 7679PC)

3) add SIZE (e.g. 7679PC/B)

For HALF SET (single knob) add /H (e.g. 7679PC/B/H).

Backplates and Rosettes ordered separately - see sections ST3 and ST4.

Finishes - See our price list or website for finish availability.

	A	B	C	D
D (diameter)	Ø 48	Ø 54	Ø 64	Ø 75
P (projection)	55*	57*	59*	62*

* total projection: add rosette or backplate thickness including collar.

Door Knobs

Two contemporary Door Knobs - in square and diamond mesh textures, both available in four sizes - designed to work in conjunction with the Rosettes & Backplates to be found in sections ST3 & ST4.

Matching Cabinet Knobs are available, see section CF1.



▲ 7681



▲ 7681B with 7821B rosette

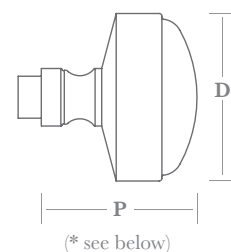

Fixings

Supplied with 8mm x 110mm stainless steel lockpoint spindle and M6 grubscrew (64mm max. door thickness); alternative spindle lengths and functions are available - see pages ST6:070 & 080.

Installation instructions supplied.

How to Order

Split Finish Sets - order as singles

1) select KNOB (e.g. 7681)

PLEASE NOTE: To work with Sprung Rosettes, the Knob needs to be machined to fit and 'SPG' must be added to the code eg. 7681SPG/...

2) add FINISH (e.g. 7681PC)

3) add SIZE (e.g. 7681PC/B)

For HALF SET (single knob) add /H (e.g. 7681PC/B/H).

Backplates and Rosettes ordered separately - see sections ST3 and ST4.



▲ 7682



▲ 7682B with 7821B rosette

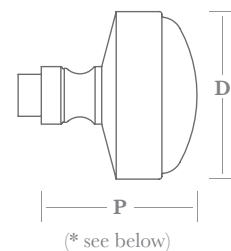

Finishes - See our price list or website for finish availability.

	A	B	C	D
D (diameter)	Ø 48	Ø 54	Ø 64	Ø 75
P (projection)	55*	57*	59*	62*

* total projection: add rosette or backplate thickness including collar.

Door Knobs

Two traditional period Door Knobs - both available in three sizes - designed to work in conjunction with the Rosettes & Backplates to be found in sections ST3 & ST4.

Complementary Thumb Turns can be found in section ST7, and Cabinet Knobs in section CF1.



▲ 7620



▲ 7620B with 6000B plate

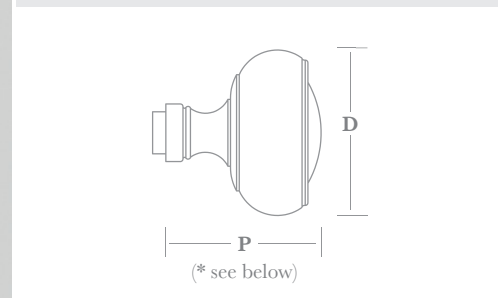

▲ 7620C with 7820C rosette

Fixings

Supplied with 8mm x 110mm stainless steel lockpoint spindle and M6 grubscrew (64mm max. door thickness); alternative spindle lengths and functions are available - see pages ST6:070 & 080. Installation instructions supplied.

How to Order

Split Finish Sets - order as singles

- 1) select KNOB (e.g. 7620)
- 2) add FINISH (e.g. 7620PC)
- 3) add SIZE (e.g. 7620PC/B)

For HALF SET (single knob) add /H (e.g. 7620PC/B/H).

Backplates and Rosettes ordered separately - see sections ST3 and ST4.

Finishes - See our price list or website for finish availability.



▲ 7625



▲ 7625B with 8700B plate

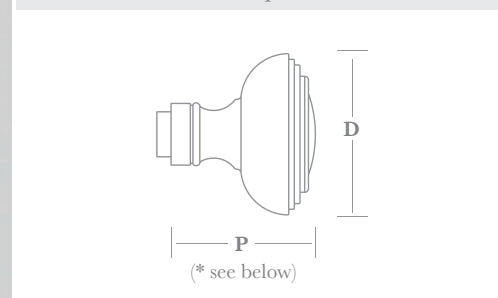

▲ 7625C with 7823C rosette

	A	B	C
D (diameter)	Ø 51	Ø 56	Ø 63
P (projection)	48*	52*	59*

* total projection: add 7mm for rosette, 6mm for backplate with flush collar & 10mm for plate with raised collar.

Door Knobs

Two classic Door Knobs - both available in four sizes - designed to work in conjunction with the Rosettes & Backplates to be found in sections ST3 & ST4.

Complementary Thumb Turns can be found in section ST7, and Cabinet Knobs in section CF1.



▲ 7650

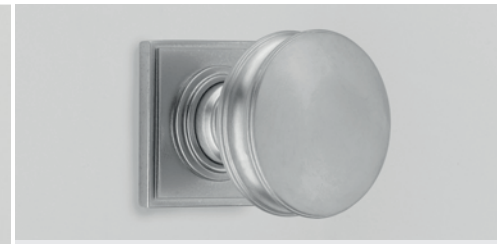

▲ 7650B with 5900B plate

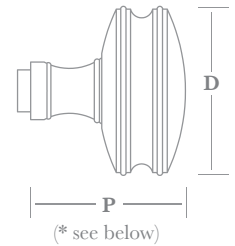

▲ 7650C with 7841C rosette

Fixings

Supplied with 8mm x 110mm stainless steel lockpoint spindle and M6 grubscrew (64mm max. door thickness); alternative spindle lengths and functions are available - see pages ST6:070 & 080.

Installation instructions supplied.

How to Order

Split Finish Sets - order as singles

- 1) select KNOB (e.g. 7650)
- 2) add FINISH (e.g. 7650PC)
- 3) add SIZE (e.g. 7650PC/B)

For HALF SET (single knob) add /H (e.g. 7650PC/B/H).

Backplates and Rosettes ordered separately - see sections ST3 and ST4.

Finishes - See our price list or website for finish availability.



▲ 7651



▲ 7651B with 5900B plate

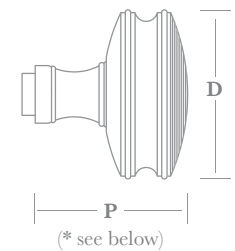

▲ 7651C with 7827C rosette

	A	B	C	D
D (diameter)	Ø 48	Ø 54	Ø 64	Ø 75
P (projection)	44*	53*	59*	65*

* total projection: add 7mm for rosette, 6mm for backplate with flush collar & 10mm for plate with raised collar.

Door Knobs

Two contemporary Door Knobs - both available in three sizes - designed to work in conjunction with the Rosettes & Backplates to be found in sections ST3 & ST4. Complementary Thumb Turns can be found in section ST7, and Cabinet Knobs in section CF1.

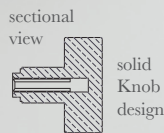
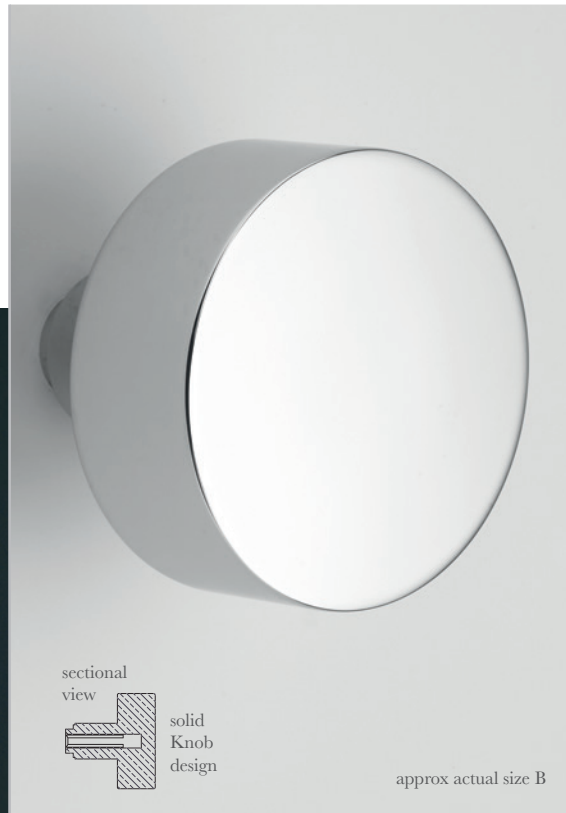

approx actual size B

▲ 7628



▲ 7628B with 4900C plate

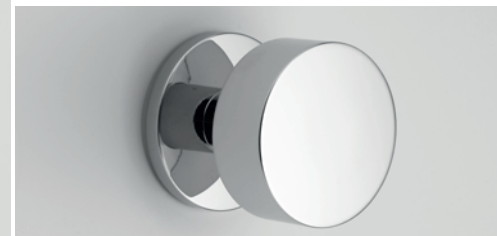
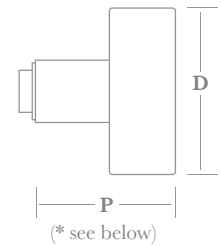

▲ 7628B with 7843C rosette

Fixings

Supplied with 8mm x 110mm stainless steel lockpoint spindle and M6 grubscrew (64mm max. door thickness); alternative spindle lengths and functions are available - see pages ST6:070 & 080.

Installation instructions supplied.

How to Order

Split Finish Sets - order as singles

- 1) select KNOB (e.g. 7628)
- 2) add FINISH (e.g. 7628PC)
- 3) add SIZE (e.g. 7628PC/B)

For HALF SET (single knob) add /H (e.g. 7628PC/B/H).

Backplates and Rosettes ordered separately - see sections ST3 and ST4.

Finishes - See our price list or website for finish availability.

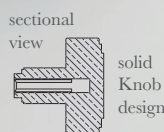

approx actual size B

▲ 7629



▲ 7629B with 5900C plate

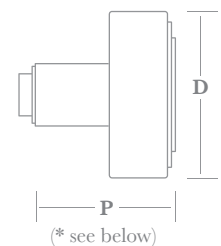

▲ 7629B with 7842C rosette

	A	B	C
D (diameter)	Ø 56	Ø 63	Ø 75
P (projection)	51	54	57

* total projection: add 7mm for rosette, 6mm for backplate with flush collar & 10mm for plate with raised collar.

Door Knobs

Two contemporary Door Knobs - both available in three sizes - designed to work in conjunction with the Rosettes & Backplates to be found in sections ST3 & ST4.

Complementary Thumb Turns can be found in section ST7, and Cabinet Knobs in section CF1.

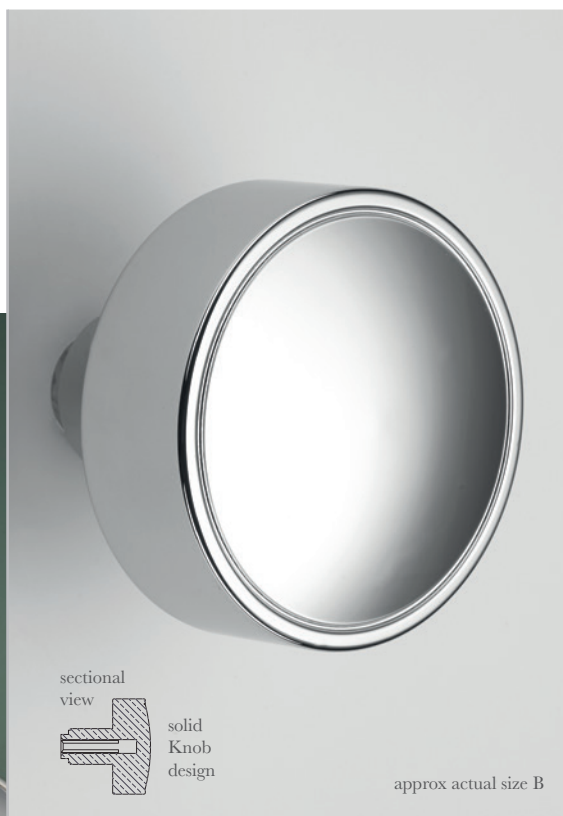

▲ 7630

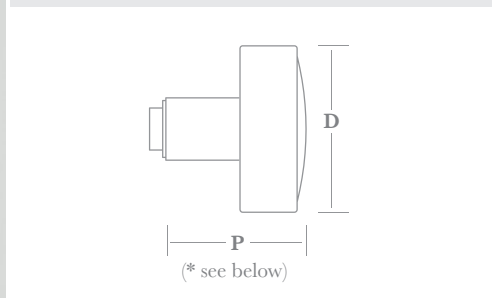

▲ 7630B with 7842C rosette

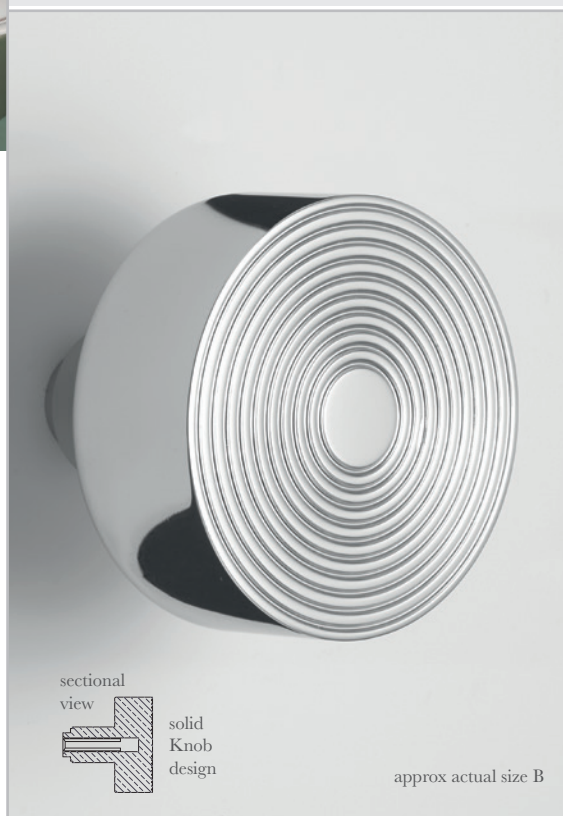

▲ 7632

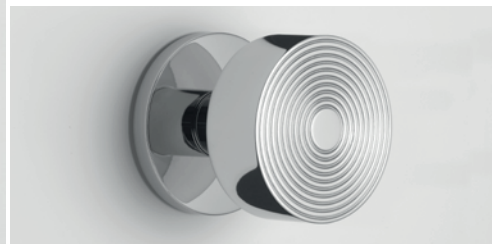
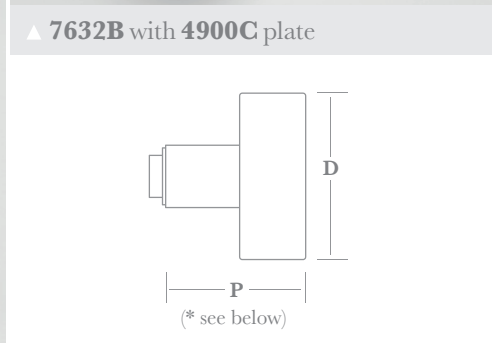
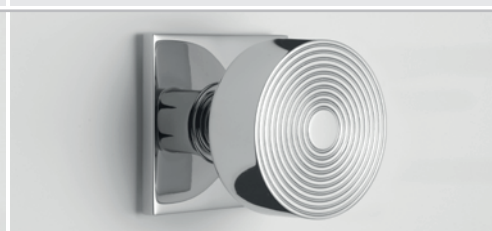

▲ 7632B with 7843C rosette

Fixings

Supplied with 8mm x 110mm stainless steel lockpoint spindle and M6 grubscrew (64mm max. door thickness); alternative spindle lengths and functions are available - see pages ST6:070 & 080.

Installation instructions supplied.

How to Order

Split Finish Sets - order as singles

- 1) select KNOB (e.g. 7630)
- 2) add FINISH (e.g. 7630PC)
- 3) add SIZE (e.g. 7630PC/B)

For HALF SET (single knob) add /H (e.g. 7630PC/B/H).

Backplates and Rosettes ordered separately - see sections ST3 and ST4.

Finishes - See our price list or website for finish availability.

	A	B	C
D (diameter)	Ø 56	Ø 63	Ø 75
P (projection) 7630	51	54	59
7632	51	54	57

* total projection: add 7mm for rosette, 6mm for backplate with flush collar & 10mm for plate with raised collar.

Door Knobs

Two classic Art Deco period Door Knobs designed to work in conjunction with the Rosettes & Backplates to be found in sections ST3 & ST4.

Complementary Thumb Turns can be found in section ST7, and Cabinet Knobs in section CF1.



▲ 7668 (square edge design)



▲ 7668 with 6700B plate

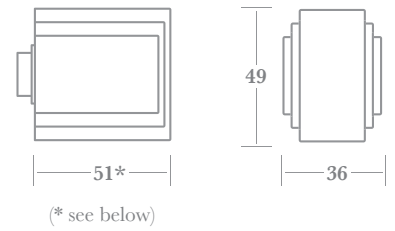

▲ 7668 with 7842B rosette

Fixings

Supplied with 8mm x 110mm stainless steel lockpoint spindle and M6 grubscrew (64mm max. door thickness); alternative spindle lengths and functions are available - see pages ST6:070 & 080.

Installation instructions supplied.

How to Order

Split Finish Sets - order as singles

1) select KNOB design (e.g. 7668)

2) add FINISH (e.g. 7668PC)

For HALF SET (single knob) add /H (e.g. 7668PC/H).

Backplates and Rosettes ordered separately - see sections ST3 and ST4.

Finishes - See our price list or website for finish availability.



▲ 7669 (round edge design)



▲ 7669 with 6800B plate

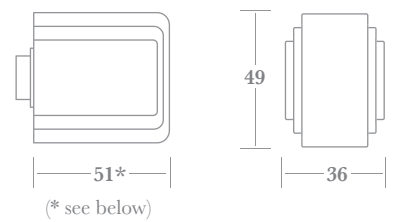

▲ 7669 with 7842B rosette

* total projection: add 7mm for rosette & 6mm for backplate. Knob design not suitable for use with backplates fitted with raised collars.

Door Knobs

Two classic 1960's period Door Knobs designed to work in conjunction with the Rosettes & Backplates to be found in sections ST3 & ST4.

Complementary Thumb Turns can be found in section ST7, and Cabinet Knobs in section CF1.

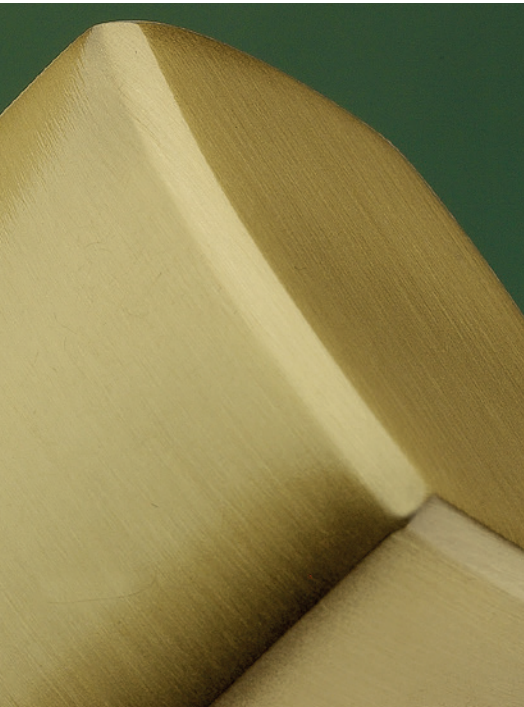

▲ 7660



▲ 7660 with 5900B plate

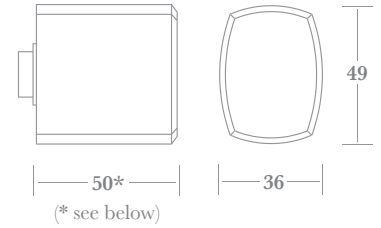

▲ 7660 with 7842B rosette



▲ 7661



▲ 7661 with 5900B plate

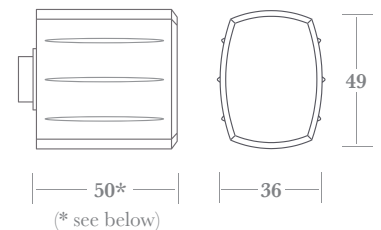

▲ 7661 with 7842B rosette

Fixings

Supplied with 8mm x 110mm stainless steel lockpoint spindle and M6 grubscrew (64mm max. door thickness); alternative spindle lengths and functions are available - see pages ST6:070 & 080.

Installation instructions supplied.

How to Order

Split Finish Sets - order as singles

- 1) select KNOB (e.g. 7660)
- 2) add FINISH (e.g. 7660PC)

For HALF SET (single knob) add /H (e.g. 7660PC/H).

Backplates and Rosettes ordered separately - see sections ST3 and ST4.

Finishes - See our price list or website for finish availability.

* total projection: add 7mm for rosette & 6mm for backplate. Knob design not suitable for use with backplates fitted with raised collars.

Door Knobs

Two traditional period Door Knobs designed to work in conjunction with the Rosettes & Backplates to be found in sections ST3 & ST4.

Complementary Thumb Turns can be found in section ST7, and Cabinet Knobs in section CF1.



▲ 7674



▲ 7674B with 7846B rosette

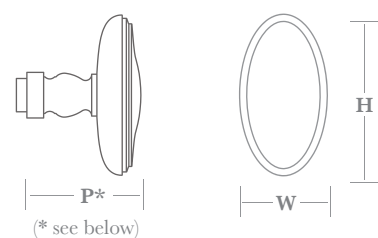

	A	B
H x W	68 x 37	76 x 42
P (projection)	52	55

Fixings

Supplied with 8mm x 110mm stainless steel lockpoint spindle and M6 grubscrew (64mm max. door thickness); alternative spindle lengths and functions are available - see pages ST6:070 & 080.

Installation instructions supplied.

How to Order

Split Finish Sets - order as singles

- 1) select KNOB (e.g. 7665)
- 2) add FINISH (e.g. 7665PC)
- 3) add SIZE (e.g. 7665PC/B)

For HALF SET (single knob) add /H (e.g. 7665PC/B/H).

For half set (single knob) as exterior pairing with a CREMONE BOLT add CM to code (e.g. 7674PC/A//CM) - see DB3:200..

Backplates and Rosettes ordered separately - see sections ST3 and ST4.

Finishes - See our price list or website for finish availability.



▲ 7665



▲ 7665A with 5900B plate

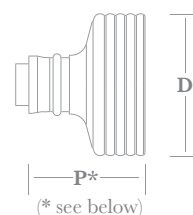

▲ 7665A with 7822B rosette

7665	A	B	C	D
D (diameter)	Ø 48	Ø 54	Ø 64	Ø 75
P (projection)	42*	44*	46*	48*

* total projection: add 7mm for rosette, 6mm for backplate with flush collar & 10mm for plate with raised collar.

Door Knobs

One contemporary and one classic 1950's period Door Knob - both designed to work in conjunction with the Rosettes & Backplates to be found in sections ST3 & ST4.

Complementary Thumb Turns can be found in section ST7, and Cabinet Knobs in section CF1.



sectional view



approx actual size

▲ 7667



▲ 7667 with 5900B plate

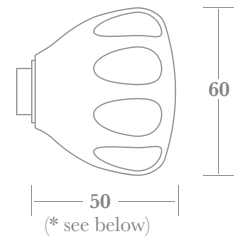

▲ 7667 with 7845B rosette

Fixings

Supplied with 8mm x 110mm stainless steel lockpoint spindle and M6 grubscrew (64mm max. door thickness); alternative spindle lengths and functions are available - see pages ST6:070 & 080.

Installation instructions supplied.

How to Order

Split Finish Sets - order as singles

- 1) select KNOB (e.g. 7667)
- 2) add FINISH (e.g. 7667PC)

For HALF SET (single knob) add /H (e.g. 7667PC/H).

Backplates and Rosettes ordered separately - see sections ST3 and ST4.

Finishes - See our price list or website for finish availability.



sectional view

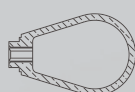

approx actual size

▲ 7672

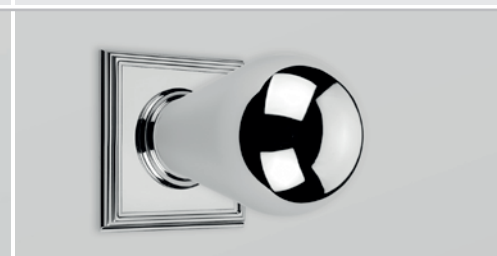

▲ 7672 with 6000B plate

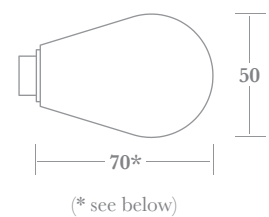

▲ 7672 with 7842B rosette

* total projection: add 7mm for rosette, 6mm for backplate with flush collar & 10mm for plate with raised collar.

Door Knobs

One contemporary and one traditional period Door Knob - both designed to work in conjunction with the Rosettes & Backplates to be found in sections ST3 & ST4.

Complementary Thumb Turns can be found in section ST7, and Cabinet Knobs in section CF1.



▲ 7666 with 4950B plate

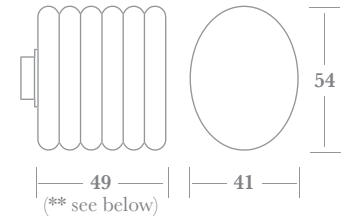

▲ 7666 with 7843B rosette

Fixings

Supplied with 8mm x 110mm stainless steel lockpoint spindle and M6 grubscrew (64mm max. door thickness); alternative spindle lengths and functions are available - see pages ST6:070 & 080. Installation instructions supplied.

How to Order

Split Finish Sets - order as singles

- 1) select KNOB (e.g. 7694)
- 2) add FINISH (e.g. 7694PC)
- 3) 7694 add SIZE (e.g. 7694PC/B)

For HALF SET (single knob) add /H (e.g. 7694PC/B/H).

Backplates and Rosettes ordered separately - see sections ST3 and ST4.

Finishes - See our price list or website for finish availability.



▲ 7694B with 6000B plate

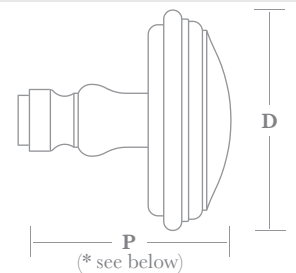

▲ 7694B with 7846B rosette

	A	B
D (diameter)	Ø 62	Ø 75
P (projection)	59*	71*

* total projection: add 7mm for rosette, 6mm for backplate with flush collar & 10mm for plate with raised collar.

** Knob design not suitable for use with backplates fitted with raised collars.

Door Knobs

One traditional period, and one classic contemporary Octagonal Door Knob - both designed to work in conjunction with the Rosettes & Backplates to be found in sections ST3 & ST4.

Complementary Thumb Turns can be found in section ST7, and Cabinet Knobs in section CF1.

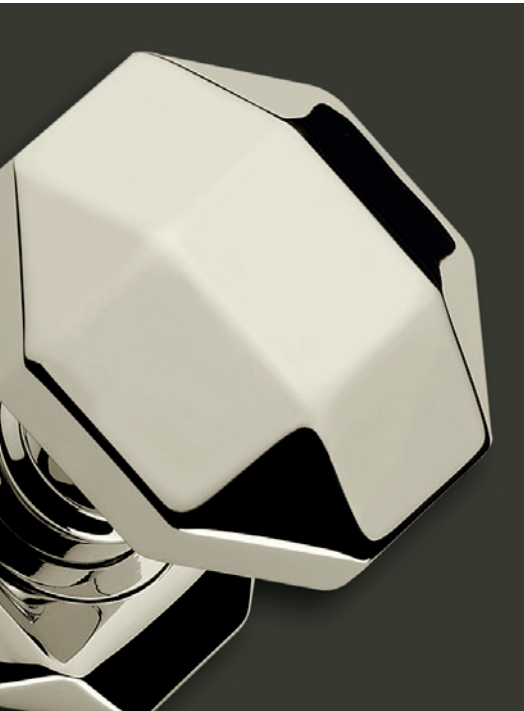

▲ 7637



▲ 7624



▲ 7637A with 7837B rosette

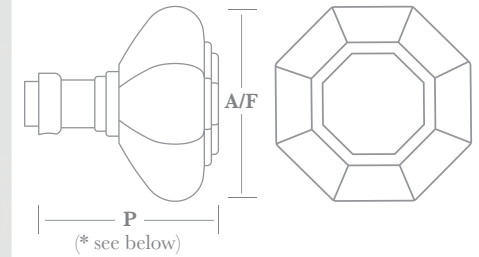

7637	A	B
A/F (across flats)	57	69
P (projection)	55	64

A/F = dimension across flats



▲ 7624A with 7824A rosette

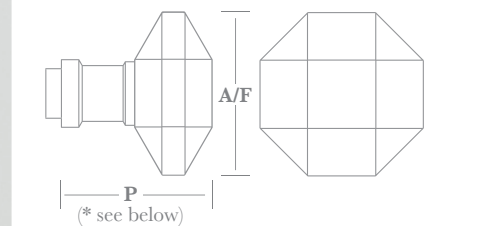

7624	A	B	C
A/F (across flats)	53	60	70
P (projection)	49	52	56

A/F = dimension across flats

Fixings

Supplied with 8mm x 110mm stainless steel lockpoint spindle and M6 grubscrew (64mm max. door thickness); alternative spindle lengths and functions are available - see pages ST6:070 & 080. Installation instructions supplied.

How to Order

Split Finish Sets - order as singles

- 1) select KNOB (e.g. 7637)
- 2) add FINISH (e.g. 7637PC)
- 3) add SIZE (e.g. 7637PC/B).

For HALF SET (single knob) add /H (e.g. 7637PC/B/H).

For half set (single knob) as exterior pairing with a CREMONE BOLT add CM to code (e.g. 7637PC/B/CM) - see DB3:200.

Backplates and Rosettes ordered separately - see sections ST3 and ST4.

Finishes - See our price list or website for finish availability.

* total projection: add 7mm for rosette, 6mm for backplate with flush collar & 10mm for plate with raised collar.

Door Knobs

One Art Deco and one Domed Oval Door Knob - both designed to work in conjunction with the Rosettes & Backplates to be found in sections ST3 & ST4.

Complementary Thumb Turns can be found in section ST7, and Cabinet Knobs in section CF1.



▲ **7631**

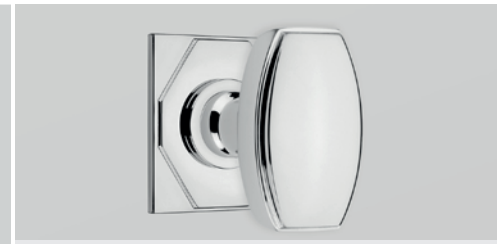

▲ **7631** with **6600B** plate

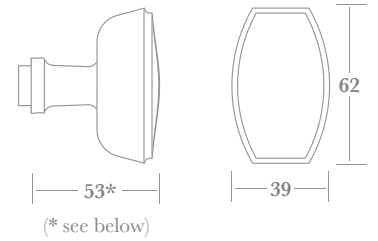

▲ **7631** with **7826** plate

Fixings

Supplied with 8mm x 110mm stainless steel lockpoint spindle and M6 grubscrew (64mm max. door thickness); alternative spindle lengths and functions are available - see pages ST6:070 & 080.

Installation instructions supplied.

How to Order

Split Finish Sets - order as singles

1) select KNOB (e.g. **7631**)

2) add FINISH (e.g. 7631**PC**)

For HALF SET (single knob) add /H (e.g. 7631**PC/H**).

For half set (single knob) as exterior pairing with a CREMONE BOLT add CM to code (e.g. 7631**PC/CM**) - see DB3:200.

Backplates and Rosettes ordered separately - see sections ST3 and ST4.

Finishes - See our price list or website for finish availability.



▲ **7657**



▲ **7657** with **5951B** plate

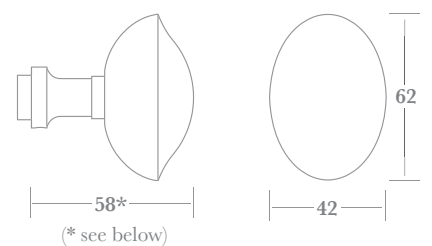

▲ **7657** with **7827B** rosette

* total projection: add 7mm for rosette, 6mm for backplate with flush collar & 10mm for plate with raised collar.

Door Knobs

Two traditional period Door Knobs - both available in two sizes - designed to work in conjunction with the Rosettes & Backplates to be found in sections ST3 & ST4.

Complementary Thumb Turns can be found in section ST7, and Cabinet Knobs in section CF1.



▲ 7648



▲ 7648B with 5951B plate

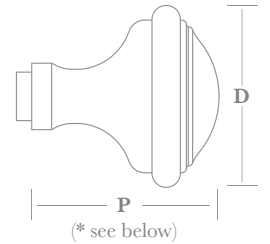

▲ 7648B with 7834B rosette

Fixings

Supplied with 8mm x 110mm stainless steel lockpoint spindle and M6 grubscrew (64mm max. door thickness); alternative spindle lengths and functions are available - see pages ST6:070 & 080.

Installation instructions supplied.

How to Order

Split Finish Sets - order as singles

- 1) select KNOB (e.g. 7619)
- 2) add FINISH (e.g. 7619PC)
- 3) add SIZE (e.g. 7619PC/B)

For HALF SET (single knob) add /H (e.g. 7619PC/B/H).

Backplates and Rosettes ordered separately - see sections ST3 and ST4.



▲ 7619



▲ 7619B with 7848B rosette

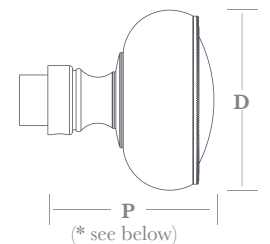

▲ 7619B with 7849B rosette

Finishes - See our price list or website for finish availability.

		D (diameter)	P (projection)
7648	A	Ø 54	52*
	B	Ø 60	62*
7619	A	Ø 50	47*
	B	Ø 57	52*
	C	Ø 63	57*

* total projection: add 7mm for rosette, 6mm for backplate with flush collar & 10mm for plate with raised collar.

Door Knobs

Two traditional period Door Knobs - both available in two sizes - designed to work in conjunction with the Rosettes & Backplates to be found in sections ST3 & ST4.

Complementary Thumb Turns can be found in section ST7, and Cabinet Knobs in section CF1.



Fixings

Supplied with 8mm x 110mm stainless steel lockpoint spindle and M6 grubscrew (64mm max. door thickness); alternative spindle lengths and functions are available - see pages ST6:070 & 080.

Installation instructions supplied.

How to Order

Split Finish Sets - order as singles

- 1) select KNOB (e.g. **7636**)
- 2) add FINISH (e.g. 7636**PC**)
- 3) add SIZE (e.g. 7636**PC/B**)

For HALF SET (single knob) add /H (e.g. 7636**PC/B/H**).

Backplates and Rosettes ordered separately - see sections ST3 and ST4.

Finishes - See our price list or website for finish availability.



▲ **7622**



▲ **7622A** with **7822B** rosette

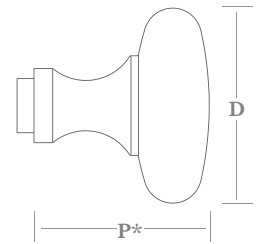

▲ **7636**



▲ **7636A** with **7838B** rosette

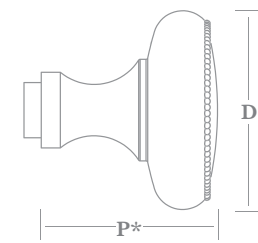

▲ **7635**



▲ **7635A** with **7822B** rosette

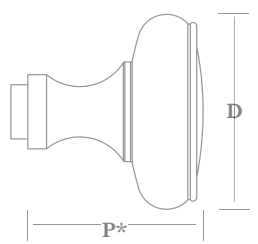

	A	B
D (diameter)	Ø 57	Ø 63
P (projection)	51*	52*

* total projection: add 7mm for rosette, 6mm for backplate with flush collar & 10mm for plate with raised collar.

Door Knobs

Two traditional period Door Knobs - both available in four sizes - designed to work in conjunction with the Rosettes & Backplates to be found in sections ST3 & ST4.

Complementary Thumb Turns can be found in section ST7, and Cabinet Knobs in section CF1.



▲ 7634

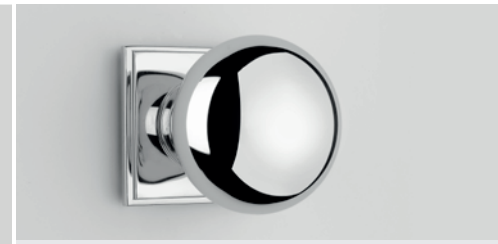

▲ 7634B with 5900B plate

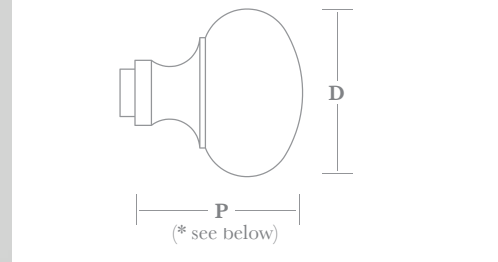

▲ 7634B with 7834B rosette

Fixings

Supplied with 8mm x 110mm stainless steel lockpoint spindle and M6 grubscrew (64mm max. door thickness); alternative spindle lengths and functions are available - see pages ST6:070 & 080.

Installation instructions supplied.

How to Order

Split Finish Sets - order as singles

- 1) select KNOB (e.g. 7638)
- 2) add FINISH (e.g. 7638PC)
- 3) add SIZE (e.g. 7638PC/B)

For HALF SET (single knob) add /H (e.g. 7638PC/B/H).

Backplates and Rosettes ordered separately - see sections ST3 and ST4.

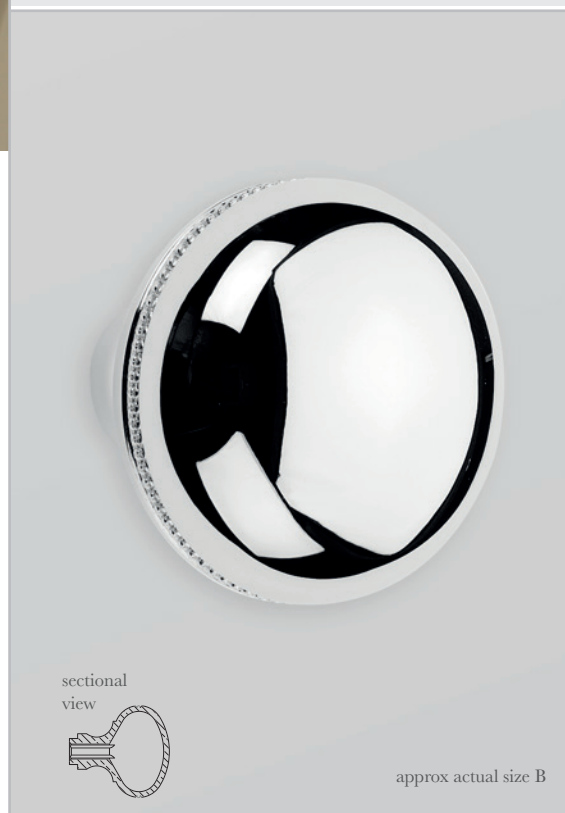

▲ 7638



▲ 7638B with 4700B plate

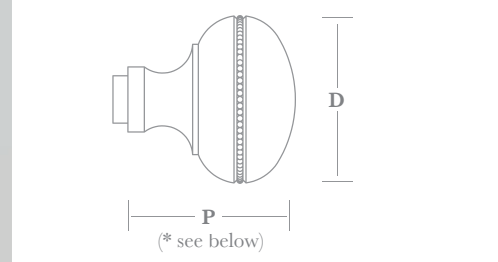

▲ 7638B with 7838B rosette

Finishes - See our price list or website for finish availability.

	AA	A	B	C
D (diameter)	Ø 44	Ø 51	Ø 57	Ø 63
P (projection)	45*	51*	56*	61*

* total projection: add 7mm for rosette, 6mm for backplate with flush collar & 10mm for plate with raised collar.

Door Knobs

Two traditional period Door Knobs - both available in four sizes - designed to work in conjunction with the Rosettes & Backplates to be found in sections ST3 & ST4. Complementary Thumb Turns can be found in section ST7, and Cabinet Knobs in section CF1.



▲ 7641



▲ 7641B with 4950B plate

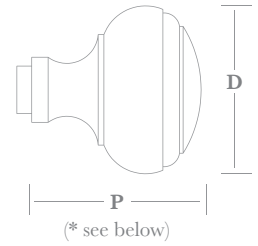

▲ 7641B with 7834B rosette

Fixings

Supplied with 8mm x 110mm stainless steel lockpoint spindle and M6 grub screw (64mm max. door thickness); alternative spindle lengths and functions are available - see pages ST6:070 & 080.

Installation instructions supplied.

How to Order

Split Finish Sets - order as singles

- 1) select KNOB (e.g. 7645)
- 2) add FINISH (e.g. 7645PC)
- 3) add SIZE (e.g. 7645PC/B)

For HALF SET (single knob) add /H (e.g. 7645PC/B/H).

Backplates and Rosettes ordered separately - see sections ST3 and ST4.



▲ 7645



▲ 7645B with 5951B plate

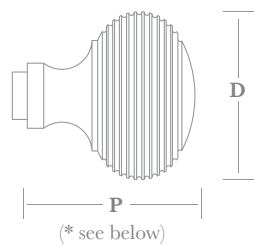

▲ 7645B with 7827B rosette

Finishes - See our price list or website for finish availability.

	AA	A	B	C
D (diameter)	Ø 44	Ø 51	Ø 57	Ø 63
P (projection)	45*	51*	56*	61*

* total projection: add 7mm for rosette, 6mm for backplate with flush collar & 10mm for plate with raised collar.

Door Knobs

Three traditional period Door Knobs designed to work in conjunction with the Rosettes & Backplates to be found in sections ST3 & ST4.

Complementary Thumb Turns can be found in section ST7, and Cabinet Knobs in section CF1.

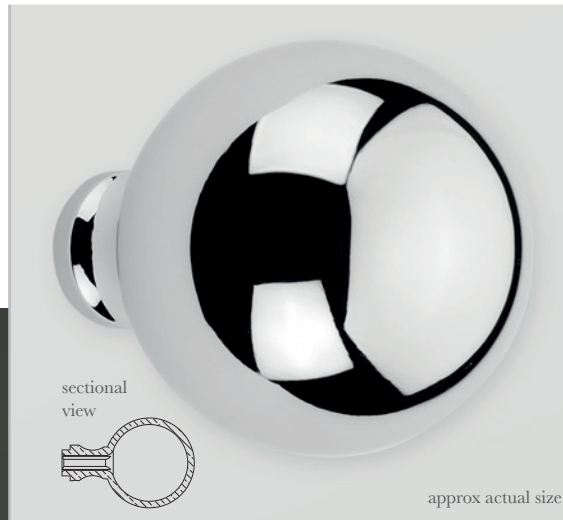

▲ 7614

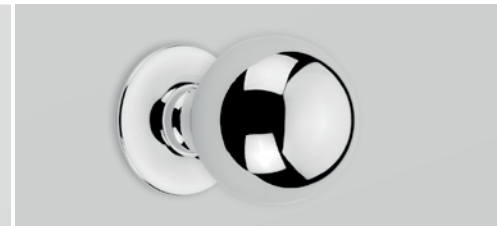

▲ 7614 with 7821B rosette

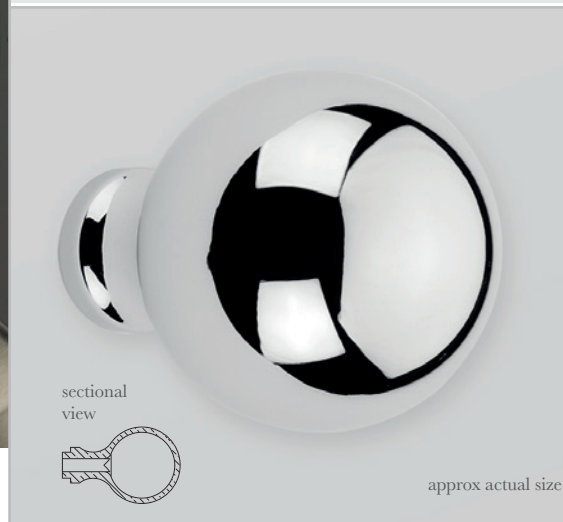
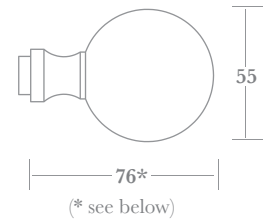

▲ 7623



▲ 7623 with 7841B rosette

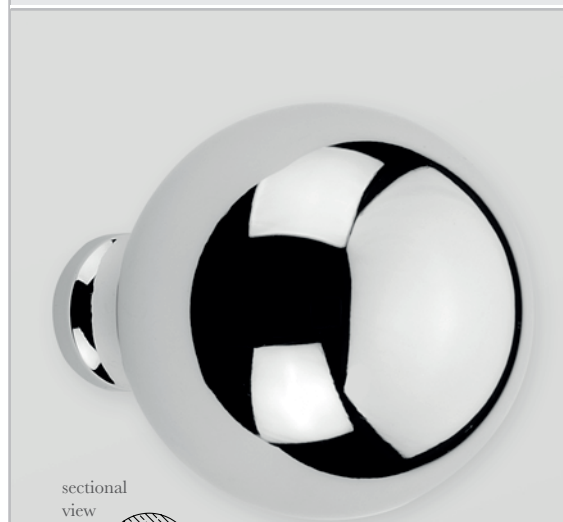
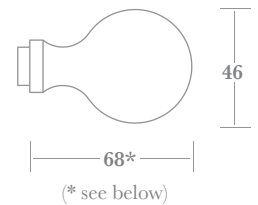

▲ 7612 (solid Knob design)



▲ 7612 with 7821B rosette

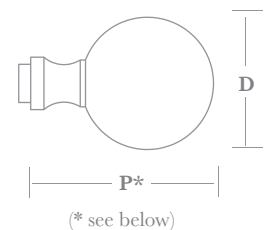

	A	B
D (diameter)	Ø 48	Ø 55
P (projection)	69*	76*

Fixings

Supplied with 8mm x 110mm stainless steel lockpoint spindle and M6 grubscrew (64mm max. door thickness); alternative spindle lengths and functions are available - see pages ST6:070 & 080.

Installation instructions supplied.

How to Order

Split Finish Sets - order as singles

1) select KNOB (e.g. 7623)

PLEASE NOTE: To work with Sprung Rosettes, the Knob needs to be machined to fit and 'SPG' must be added to the code eg. 7623SPG/...

2) add FINISH (e.g. 7623PC)

For HALF SET (single knob) add /H (e.g. 7623PC/H).

Backplates and Rosettes ordered separately - see sections ST3 and ST4.

Finishes - See our price list or website for finish availability.

* total projection: add rosette or backplate thickness including collar.

Door Knobs

Three traditional period Door Knobs designed to work in conjunction with the Rosettes & Backplates to be found in sections ST3 & ST4.

Complementary Thumb Turns can be found in section ST7, and Cabinet Knobs in section CF1.

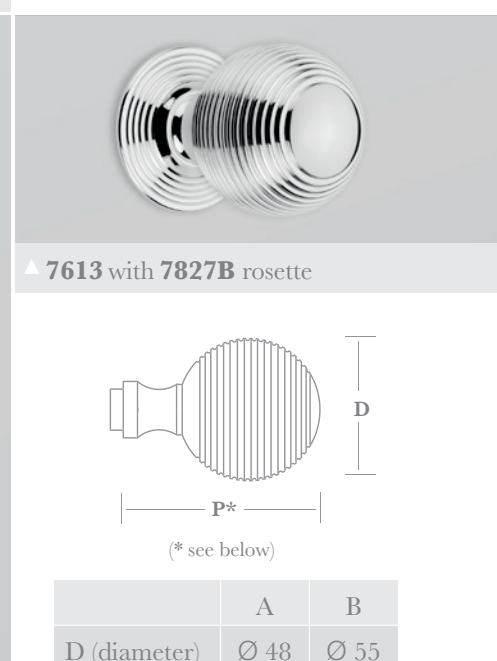
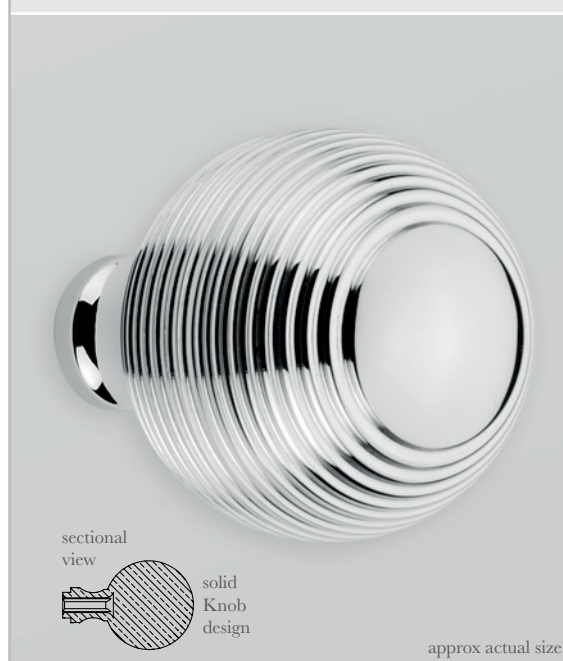
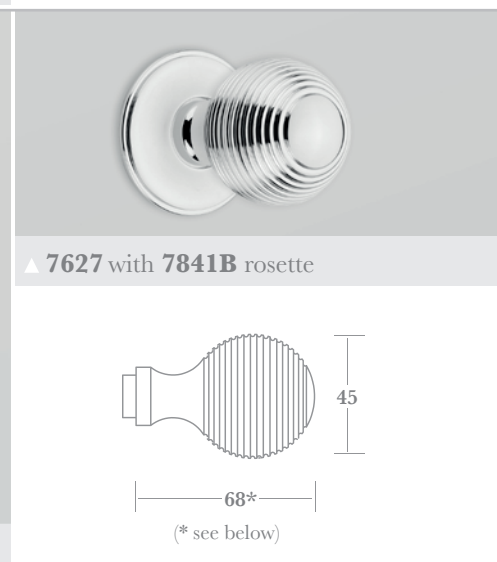
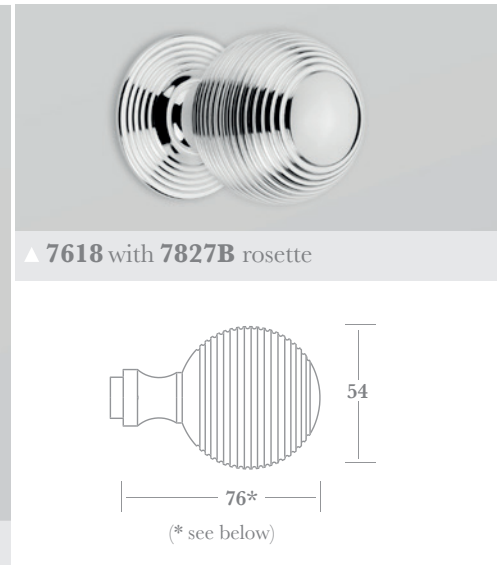
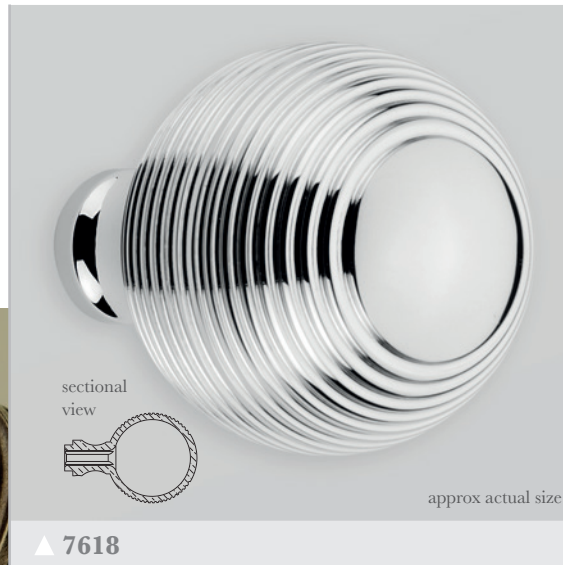

	A	B
D (diameter)	Ø 48	Ø 55
P (projection)	69*	76*

Fixings

Supplied with 8mm x 110mm stainless steel lockpoint spindle and M6 grubscrew (64mm max. door thickness); alternative spindle lengths and functions are available - see pages ST6:070 & 080.

Installation instructions supplied.

How to Order

Split Finish Sets - order as singles

1) select KNOB (e.g. **7627**)

PLEASE NOTE: To work with Sprung Rosettes, the Knob needs to be machined to fit and 'SPG' must be added to the code eg. 7627SPG/...

2) add FINISH (e.g. 7627**PC**)

For HALF SET (single knob) add /H (e.g. 7627PC/**H**).

Backplates and Rosettes ordered separately - see sections ST3 and ST4.

Finishes - See our price list or website for finish availability.

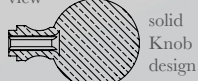

* total projection: add rosette or backplate thickness including collar.

Door Knobs

Two Oval Door Knobs designed to work in conjunction with the Rosettes & Backplates to be found in sections ST3 & ST4.

Complementary Thumb Turns can be found in section ST7, and Cabinet Knobs in section CF1.



Fixings

Supplied with 8mm x 110mm stainless steel lockpoint spindle and M6 grubscrew (64mm max. door thickness); alternative spindle lengths and functions are available - see pages ST6:070 & 080.

Installation instructions supplied.

How to Order

Split Finish Sets - order as singles

- 1) select KNOB (e.g. **7621**)
- 2) add FINISH (e.g. 7621**PC**)

For HALF SET (single knob) add /H (e.g. 7621**PC/H**).

For half set (single knob) as exterior pairing with a CREMONE BOLT add CM to code (e.g. 7621**PC/CM**) - see DB3:200.

Backplates and Rosettes ordered separately - see sections ST3 and ST4.

Finishes - See our price list or website for finish availability.



▲ **7616**



▲ **7616** with **6000B** plate

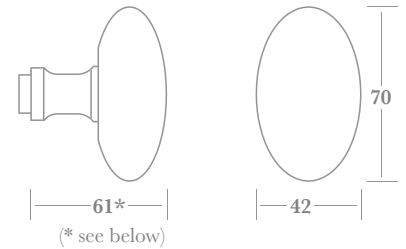

▲ **7616** with **7846B** rosette



▲ **7621**



▲ **7621** with **6000B** plate

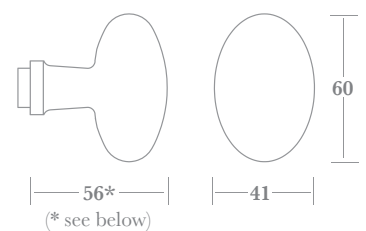

▲ **7621** with **7847B** rosette

* total projection: add 7mm for rosette, 6mm for backplate with flush collar & 10mm for plate with raised collar.

Door Knobs

One 1950's inspired, and one traditional period, Door Knob - both designed to work in conjunction with the Rosettes & Backplates to be found in sections ST3 & ST4.

Complementary Thumb Turns can be found in section ST7, and Cabinet Knobs in section CF1.



▲ 7615



▲ 7615 with 5900B plate

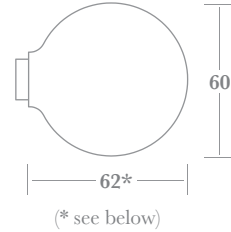

▲ 7615 with 7845B rosette

Fixings

Supplied with 8mm x 110mm stainless steel lockpoint spindle and M6 grubscrew (64mm max. door thickness); alternative spindle lengths and functions are available - see pages ST6:070 & 080. Installation instructions supplied.

How to Order

Split Finish Sets - order as singles

- 1) select KNOB (e.g. 7615)
- 2) add FINISH (e.g. 7615PC)
- 3) 7653 add SIZE (e.g. 7653PC/B)

For HALF SET (single knob) add /H (e.g. 7615PC/H).

Backplates and Rosettes ordered separately - see sections ST3 and ST4.

Finishes - See our price list or website for finish availability.



▲ 7653



▲ 7653B with 5900B plate

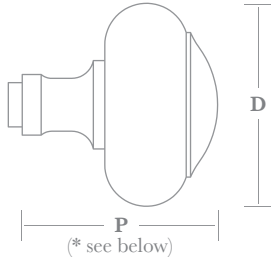

▲ 7653B with 7834B rosette

	A	B
D (diameter)	Ø 60	Ø 73
P (projection)	58*	70*

* total projection: add 7mm for rosette, 6mm for backplate with flush collar & 10mm for plate with raised collar.