

# Round Flush Pulls

A choice of nine Flush Pull designs suitable for sliding pocket doors. All are available in three diameters with three depth options. Face, Pocket or Adhesive fixed are offered with a choice of functions, whilst a Rear Bolt fixed version is available as a plain Pull only. Plain Pulls are also available in pairs back-to-back fixed (see DF4:002).

7255B/9MM/AF/PN



7255B/11MM/PF shown

**PF** pocket fixed  
(available 11 & 14mm depths only)

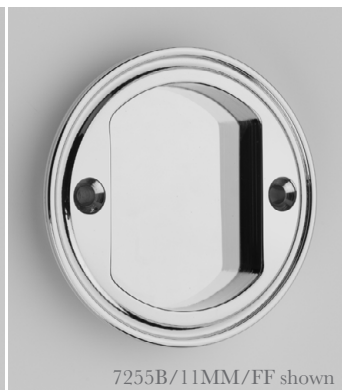

7255B/11MM/FF shown

**FF** face fixed  
(available in all depths)



7255B/11MM/AF shown

**AF** adhesive fixed  
(available in all depths)  
**BF** rear bolt fixed  
(available in all depths)

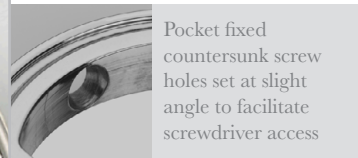

Pocket fixed countersunk screw holes set at slight angle to facilitate screwdriver access



Overall Depth	9*	11	14
Code	9MM	11MM	14MM

\* pocket fixing not available 9mm deep



**FUNCTION OPTIONS**  
See page DF4:002

Computer generated images (B size shown, 11mm depth, adhesive fix)

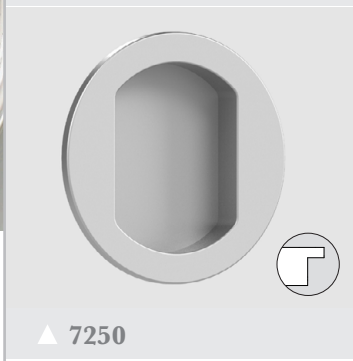

▲ 7250

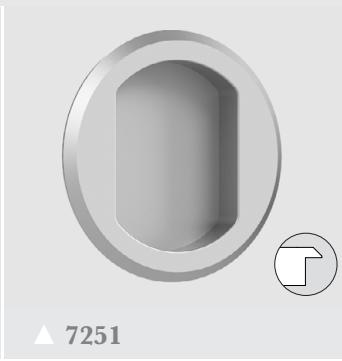

▲ 7251

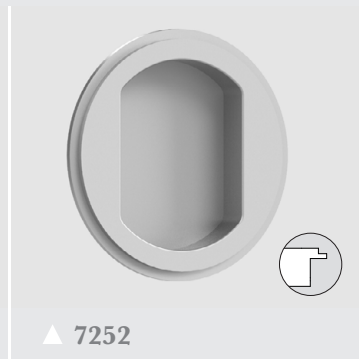

▲ 7252



▲ 7253

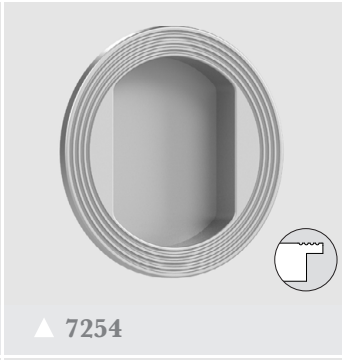

▲ 7254

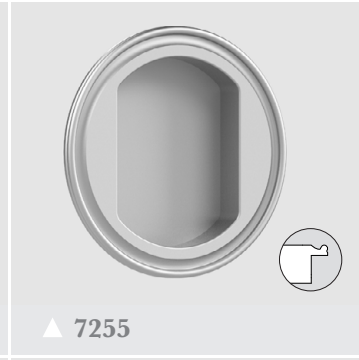

▲ 7255



▲ 7256 (raised bead design)

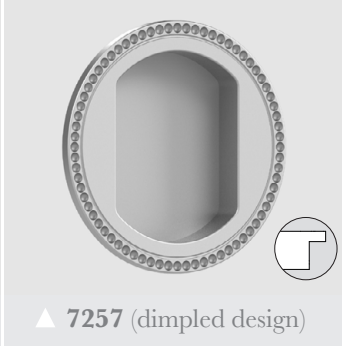

▲ 7257 (dimpled design)

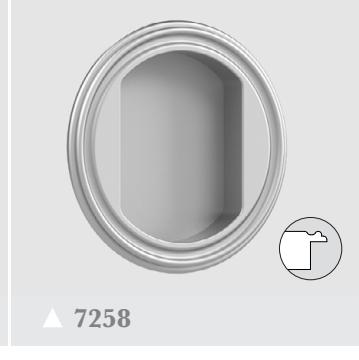

▲ 7258

## Fixings

Face fixed & Pocket fixed versions supplied with finish matched no.6 x 19mm wood screws.

Rear Bolt fixed version supplied with M4 x 50mm break-off flange head machine screws.

Swing Cover Release versions supplied with nickel plated key.

## How to Order

Refer to page DF4:002 for size & function codes:

- 1) select DESIGN (e.g. 7254)
- 2) add SIZE (e.g. 7254B)
- 3) choose DEPTH OPTION (e.g. 7254B/11MM).
- 4) choose FIXING METHOD (e.g. 7254B/11MM/PF)
- 5) add FINISH (e.g. 7254B/11MM/PF/PC)
- 6) add FUNCTION if required (e.g. 7254B/11MM/PF/PC/SR).

**Finishes** - See our price list or website for finish availability.

# Round Flush Pulls

## Sizes

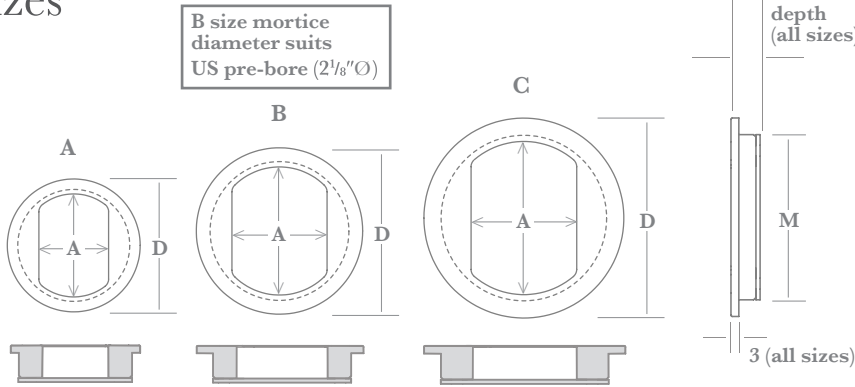

<b>Overall Depth</b>	9†	11	14
<b>Code</b>	9MM	11MM	14MM

† pocket fixing not available 9mm deep

	A*	B	C
Diameter (D)	Ø 50	Ø 63	Ø 76
Aperture (A)	38 x 25	47 x 35	57 x 39
Mortice Size (M)	Ø 45	Ø 55	Ø 64

\* not available with turn or release functions

## Keyhole & Privacy Functions (B size shown)

▲ **KH** Keyhole

▲ **EC** Euro Cylinder Cutout

▲ **TS** Turn (Square Spindle orientation)  
▲ **TD** Turn (Diamond Spindle orientation) (not available A size)

▲ **SR** Swing Cover Release (not available A size)  
release key supplied

▲ **CR** Coin Release (not available A size)

## Mortice Depths (C size shown)

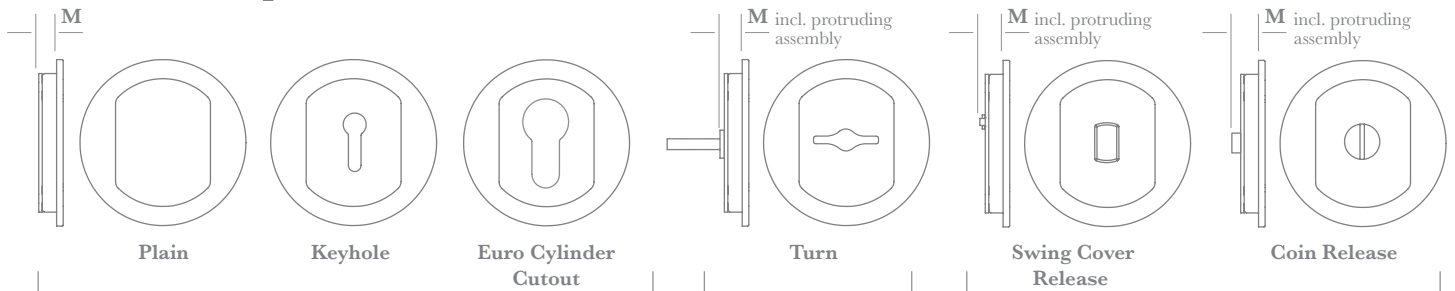

M Mortice Depths								
Plain Keyhole Euro Cylinder Cutout			Turn NB. Mortice depths shown below include the extra 2mm required to accommodate the turn assembly.			Swing Cover Release Coin Release NB. Mortice depths shown below include the extra 2.5mm required to accommodate the swing cover assembly and coin release.		
9MM	11MM	14MM	9MM	11MM	14MM	9MM	11MM	14MM
7	9	12	9	11	14	9.5	11.5	14.5

## Back-to-Back Fixing

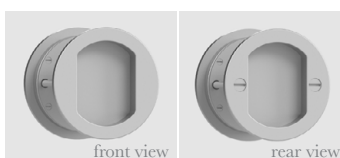

Plain (non-functioning) Pulls are available as pairs back-to-back fixed. Please contact us for coding information.

# Round Flush Pulls - Lipped Design

A choice of nine Lipped Flush Pull designs suitable for both hinged doors and sliding drawers. All are available in three diameters with three depth options. Face, Pocket or Adhesive fixed are offered with a choice of functions, whilst a Rear Bolt fixed version is available as a plain pull only. Plain Pulls are also available in pairs back-to-back fixed (see DF4:004).

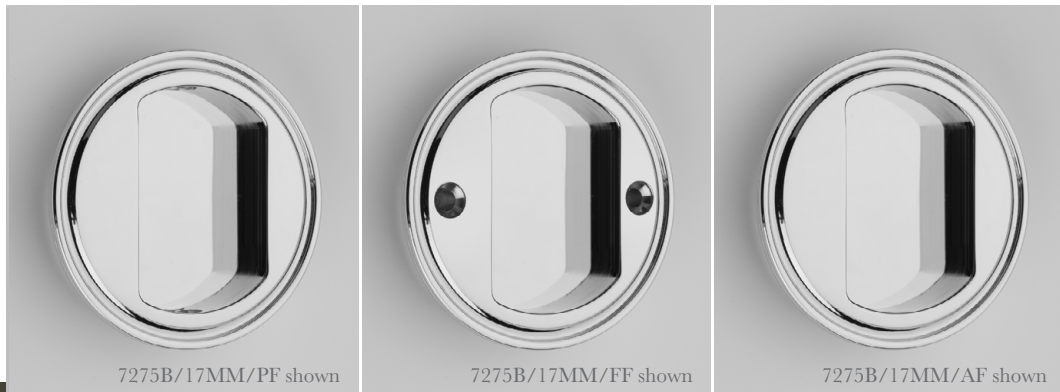

7278B/17MM/PF/PN



▲ **PF** pocket fixed

▲ **FF** face fixed  
(available in all depths)

▲ **AF** adhesive fixed  
(available in all depths)  
**BF** rear bolt fixed  
(available in all depths)

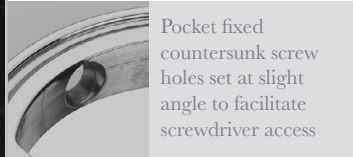

Overall Depth	14	17	21
Code	14MM	17MM	21MM

**FUNCTION OPTIONS**  
See page DF4:004

Computer generated images (B size shown, 14mm depth, adhesive fix)

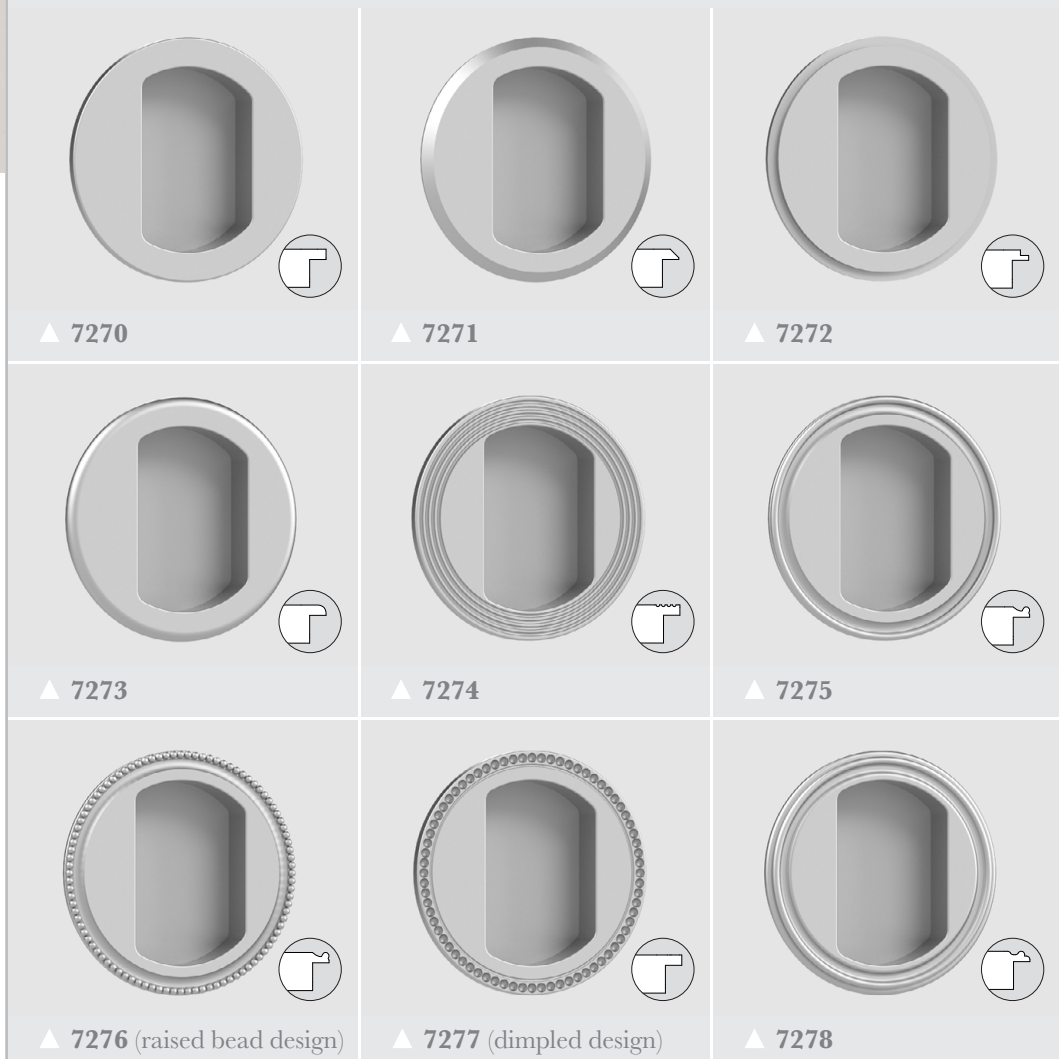

## Fixings

Face fixed versions supplied with finish matched wood screws:  
17mm & 21mm depth: no.6 x 32mm;  
14mm no. 6 x 25mm.

Pocket fixed versions supplied with finish matched no.6 x 19mm wood screws.

Rear Bolt fixed version supplied with M4 x 50mm break-off flange head machine screws.

Swing Cover Release versions supplied with nickel plated key.

## How to Order

Refer to page DF4:004 for size & function codes:

- 1) select DESIGN (e.g. 7274)
- 2) add SIZE (e.g. 7274A)
- 3) choose DEPTH OPTION (e.g. 7274A/17MM)
- 4) choose FIXING METHOD (e.g. 7274A/17MM/PF)
- 5) add FINISH (e.g. 7274A/17MM/PF/PC).
- 6) add FUNCTION if required (e.g. 7274A/17MM/PF/PC/KHL).

**Finishes** - See our price list or website for finish availability.

# Round Flush Pulls - Lipped Design

## Sizes

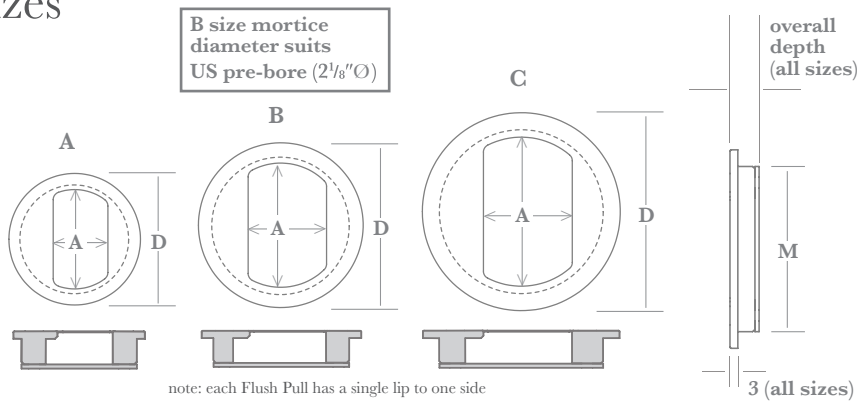

Overall Depth	14	17	21
Code	14MM	17MM	21MM

	A*	B*	C
Diameter (D)	Ø 50	Ø 63	Ø 76
Aperture (A)	38 x 21	47 x 30	57 x 34
Mortice Size (M)	Ø 45	Ø 55	Ø 64

\* not available with turn or release functions (these functions are only available on size C)

## Keyhole & Privacy Functions (C size shown)

<p>RH shown</p> <p>▲ Keyhole <b>KHL</b> (LH Pull) <b>KHR</b> (RH Pull)</p>	<p>TS SQUARE TD DIAMOND</p> <p>▲ Turn (available C size only) <b>TS</b> (Square Spindle orientation) <b>TD</b> (Diamond Spindle orientation)</p>	<p>release key supplied RH shown</p> <p>▲ Swing Cover Release (available C size only) <b>SRL</b> (LH Pull) <b>SRR</b> (RH Pull)</p>	<p>▲ <b>CR</b> Coin Release (available C size only)</p>
--	--	---	---

## Mortice Depths (C size shown)

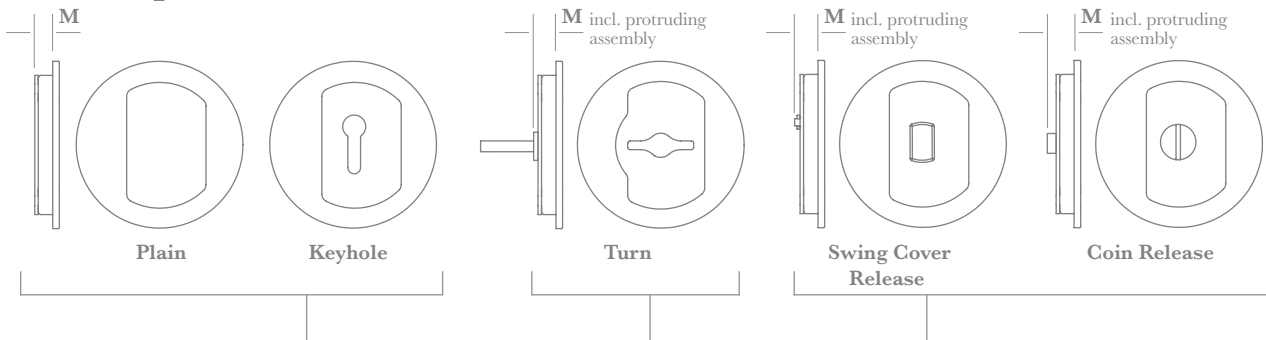

M Mortice Depths								
Plain Keyhole			Turn NB. Mortice depths shown below include the extra 2mm required to accommodate the turn assembly.			Swing Cover Release Coin Release NB. Mortice depths shown below include the extra 2.5mm required to accommodate the swing cover assembly and coin release.		
14MM	17MM	21MM	14MM	17MM	21MM	14MM	17MM	21MM
12	15	19	14	17	21	14.5	17.5	21.5

## Back-to-Back Fixing

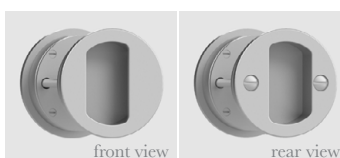

Plain (non-functioning) Pulls are available as pairs back-to-back fixed. Please contact us for coding information.

# Square Flush Pulls

A choice of nine Flush Pull designs suitable for sliding pocket doors. All are available in three sizes with three depth options. Face, Pocket or Adhesive fixed are offered with a choice of functions, whilst a Rear Bolt fixed version is available as a plain pull only. Plain Pulls are also available in pairs back-to-back fixed (see DF4:006).

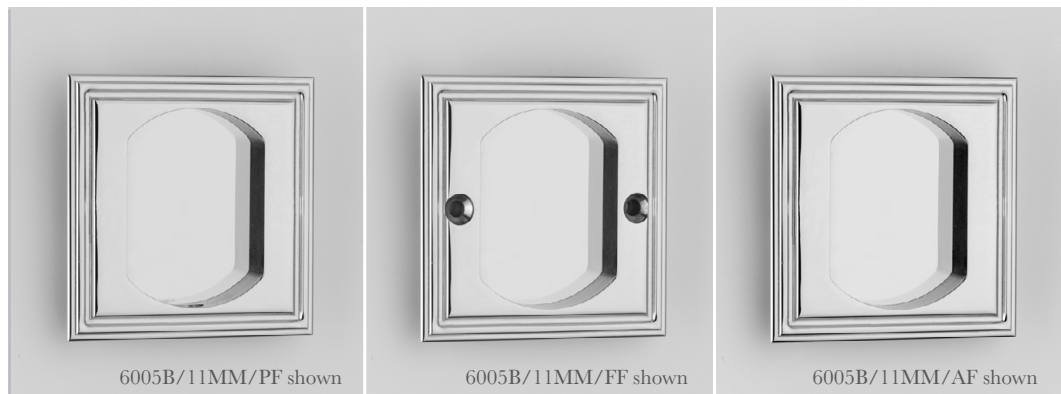

▲ **PF** pocket fixed  
(available 11 & 14mm depths only)

▲ **FF** face fixed  
(available in all depths)

▲ **AF** adhesive fixed  
(available in all depths)  
**BF** rear bolt fixed  
(available in all depths)

6005B/11MM/FF/PN/SR



Overall Depth	9*	11	14
Code	9MM	11MM	14MM

\* pocket fixing not available 9mm deep



Computer generated images (B size shown, 11mm depth, adhesive fix)

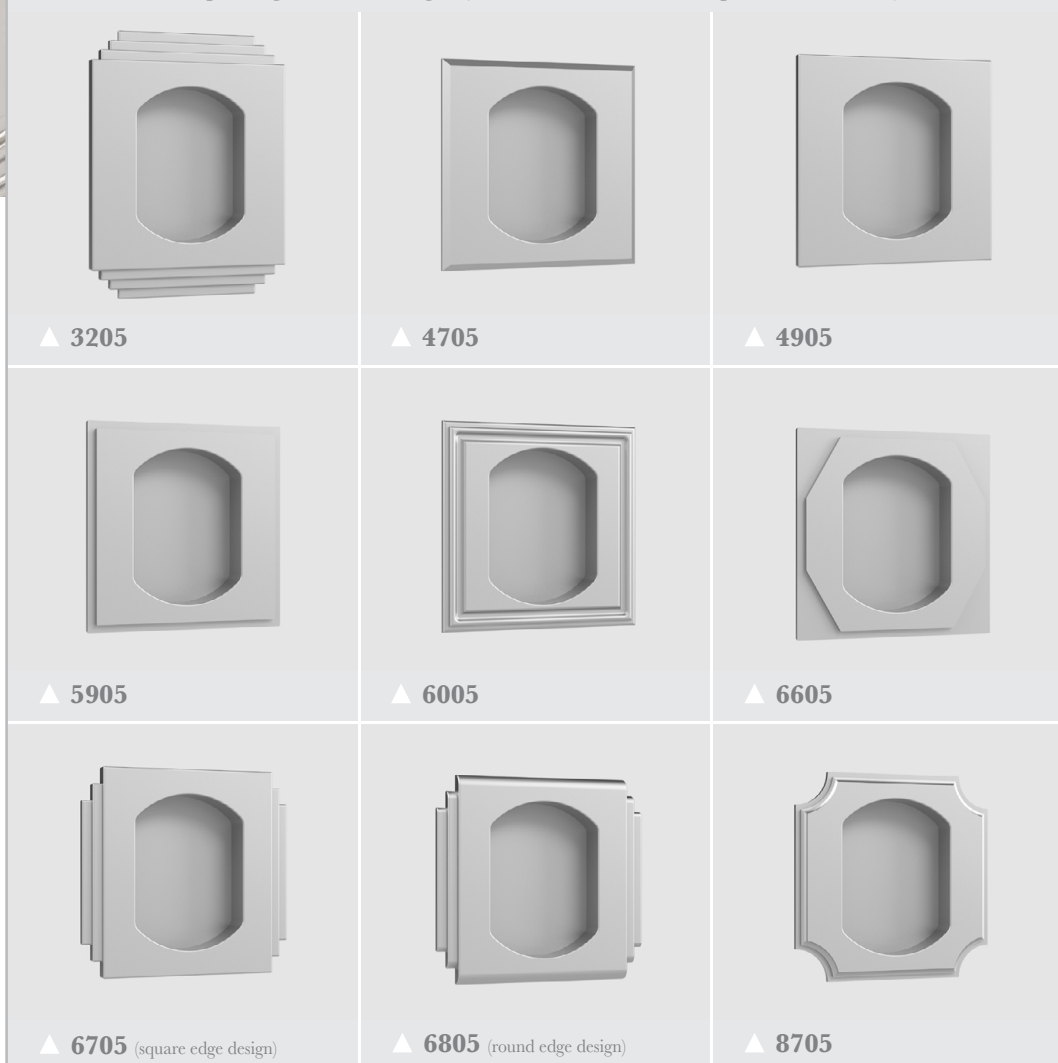

## Fixings

Face fixed & Pocket fixed versions supplied with finish matched no.6 x 19mm wood screws.

Rear Bolt fixed version supplied with M4 x 50mm break-off flange head machine screws.

Swing Cover Release versions supplied with nickel plated key.

## How to Order

Refer to page DF4:006 for size & function codes:

- 1) select DESIGN (e.g. 5905)
- 2) add SIZE (e.g. 5905**B**)
- 3) choose DEPTH OPTION (e.g. 5905B/**11MM**)
- 4) choose FIXING METHOD (e.g. 5905B/11MM/**PF**)
- 5) choose FINISH (e.g. 5905B/11MM/PF/**PC**)
- 6) add FUNCTION if required (e.g. 5905B/11MM/PF/PC/**SR**).

**Finishes** - See our price list or website for finish availability.

# Square Flush Pulls - sizes, functions & mortise depths

## Sizes

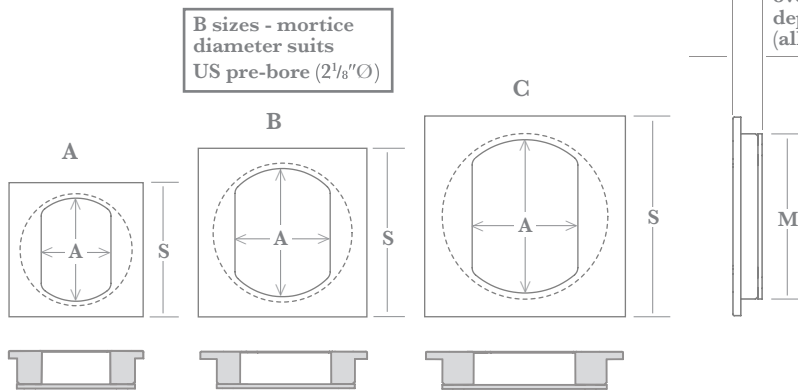

Overall Depth	9†	11	14
Code	9MM	11MM	14MM

† pocket fixing not available 9mm deep

	A*	B	C
Size (S)	50	63	76
3205 (H x W)	68 x 50	81 x 63	94 x 76
6705/6805 (H x W)	50 x 54	63 x 67	76 x 76
Aperture (A)	38 x 25	47 x 35	57 x 39
Mortise Size (M)	Ø 45	Ø 55	Ø 64

\* not available with turn or release functions

## Keyhole & Privacy Functions (B size shown)

▲ **KH** Keyhole

▲ **EC** Euro Cylinder Cutout

▲ **TS** Turn (Square Spindle orientation)  
**TD** Turn (Diamond Spindle orientation) (not available A size)

▲ **SR** Swing Cover Release (not available A size)

▲ **CR** Coin Release (not available A size)

## Mortise Depths & Face Plate Thicknesses

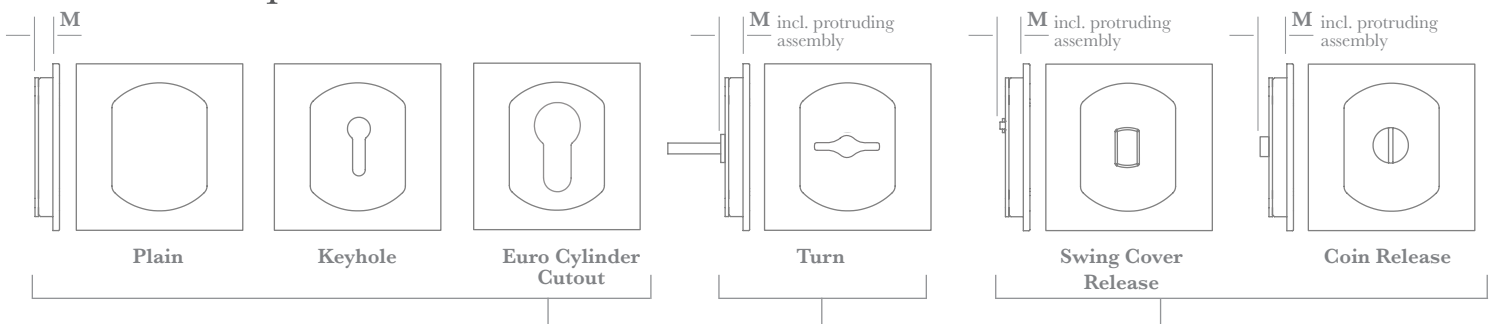

Face Plate Thickness	M Mortise Depths									
	Plain Keyhole Euro Cylinder Cutout			Turn NB. Mortise depths shown below include the extra 2mm required to accommodate the turn assembly.			Swing Cover Release Coin Release NB. Mortise depths shown below include the extra 2.5mm required to accommodate the swing cover assembly and coin release.			
PLATE DESIGNS	T	9MM	11MM	14MM	9MM	11MM	14MM	9MM	11MM	14MM
32--, 67--, 68--, 87--	4	6	8	11	8	10	13	8.5	10.5	13.5
47--, 49--, 59--, 60--, 66--	3	7	9	12	9	11	14	9.5	11.5	14.5

## Back-to-Back Fixing

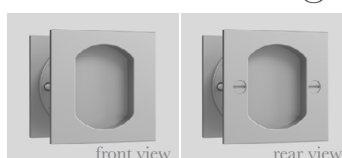

Plain (non-functioning) Pulls are available as pairs back-to-back fixed. Please contact us for coding information.

# Square Flush Pulls - Lipped Design

A choice of nine Lipped Flush Pull designs suitable for both hinged doors and sliding drawers. All are available in three sizes with three depth options. Face, Pocket or Adhesive fixed are offered with a choice of functions, whilst a Rear Bolt fixed version is available as a plain pull only. Plain Pulls are also available in pairs back-to-back fixed (see DF4:008). Custom sizes are available upon request - surcharge may apply.

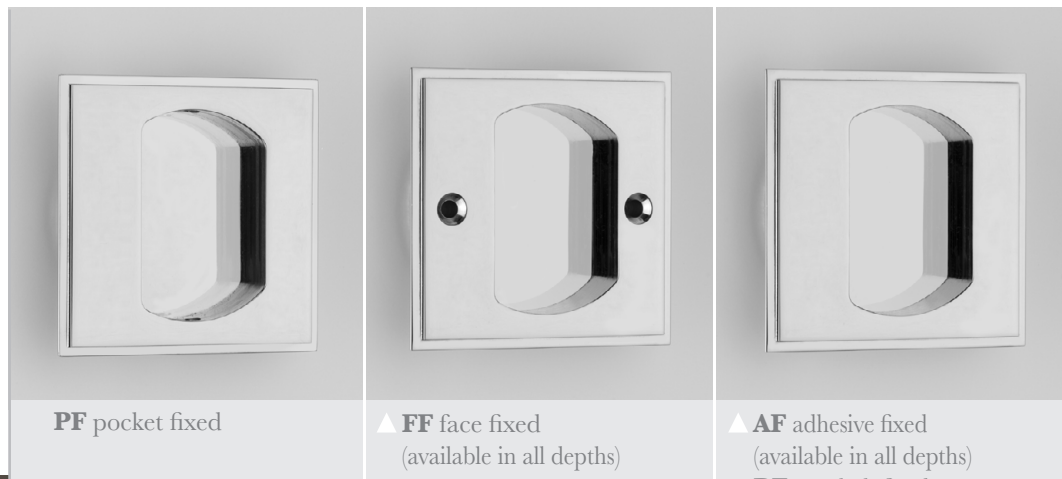

**PF** pocket fixed

▲ **FF** face fixed  
(available in all depths)

▲ **AF** adhesive fixed  
(available in all depths)  
**BF** rear bolt fixed  
(available in all depths)



Overall Depth	14	17	21
Code	14MM	17MM	21MM



5906B/14MM/PF/PN



## Fixings

Face fixed versions supplied with finish matched wood screws:  
17mm & 21mm depth: no.6 x 32mm;  
14mm no. 6 x 25mm.

Pocket fixed versions supplied with finish matched no.6 x 19mm wood screws.

Rear Bolt fixed version supplied with M4 x 50mm break-off flange head machine screws.

Swing Cover Release versions supplied with nickel plated key.

## How to Order

Refer to page DF4:008 for size & function codes:

- 1) select DESIGN (e.g. 3206)
- 2) add SIZE (e.g. 3206C)
- 3) choose DEPTH OPTION (e.g. 3206C/17MM).
- 4) choose FIXING METHOD (e.g. 3206C/17MM/PF)
- 5) add FINISH (e.g. 3206C/17MM/PF/PC)
- 6) add FUNCTION if required (e.g. 3206C/17MM/PF/PC/SRL).

**Finishes** - See our price list or website for finish availability.

Computer generated images (B size shown, 11mm depth, adhesive fix)

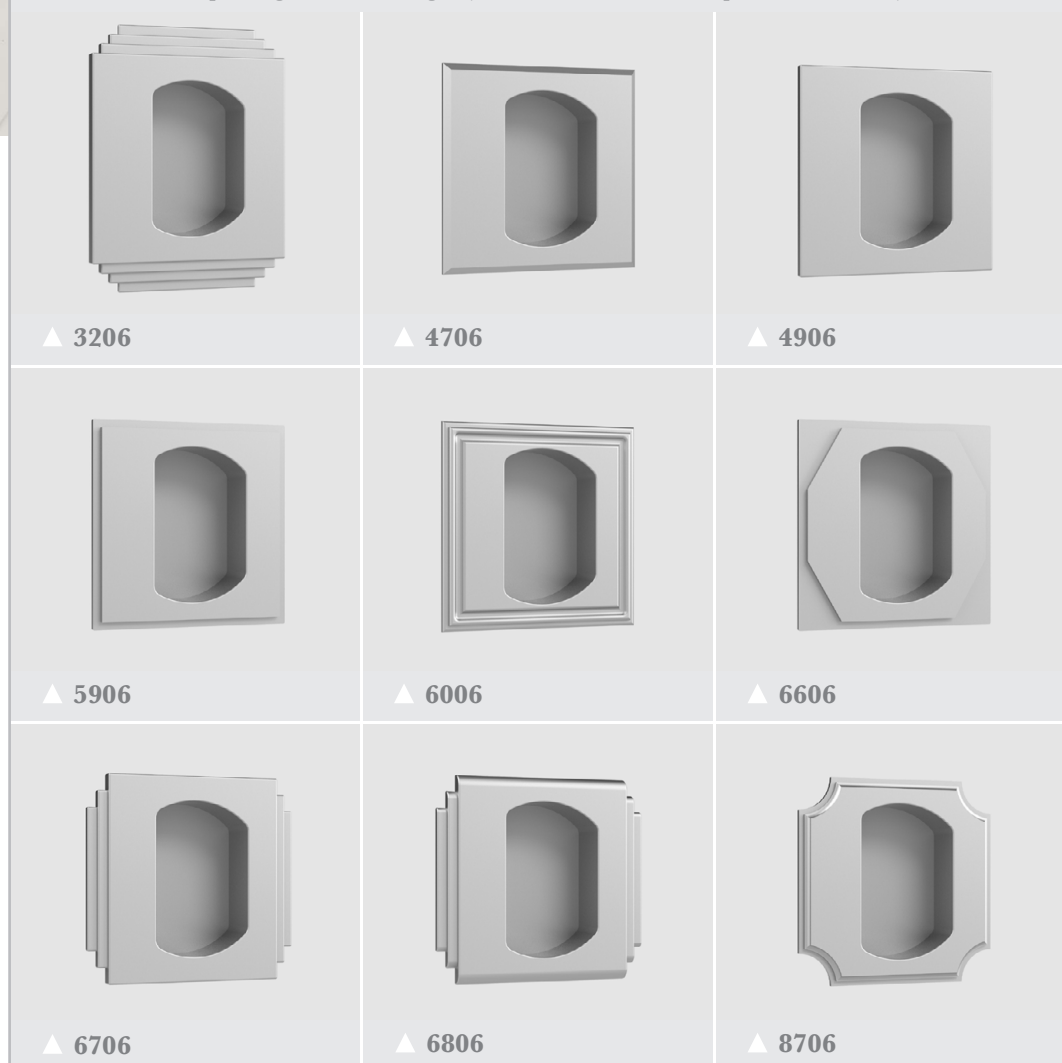

# Square Flush Pulls - Lipped Design

## Sizes

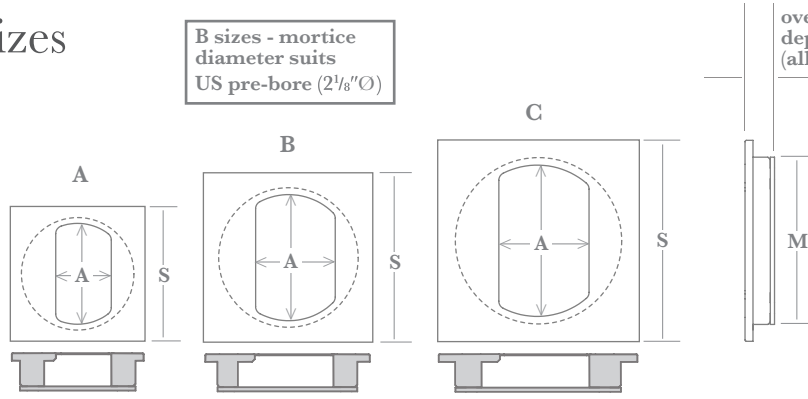

Overall Depth	14	17	21
Code	14MM	17MM	21MM

	A*	B*	C
Size (S)	50	63	76
3206 (H x W)	68 x 50	81 x 63	94 x 76
6706/6806 (H x W)	50 x 54	63 x 67	76 x 76
Aperture (A)	38 x 21	47 x 30	57 x 34
Mortice Size (M)	Ø 45	Ø 55	Ø 64

## Keyhole & Privacy Functions

\* not available with turn or release functions (these functions are only available on size C)

▲ Keyhole  
**KHL** (LH Pull)  
**KHR** (RH Pull)

▲ Turn (available C size only)  
**TS** (Square Spindle orientation)  
**TD** (Diamond Spindle orientation)

▲ Swing Cover Release (available C size only)  
**SRL** (LH Pull)  
**SRR** (RH Pull)

▲ **CR** Coin Release (available C size only)

## Mortice Depths & Face Plate Thicknesses

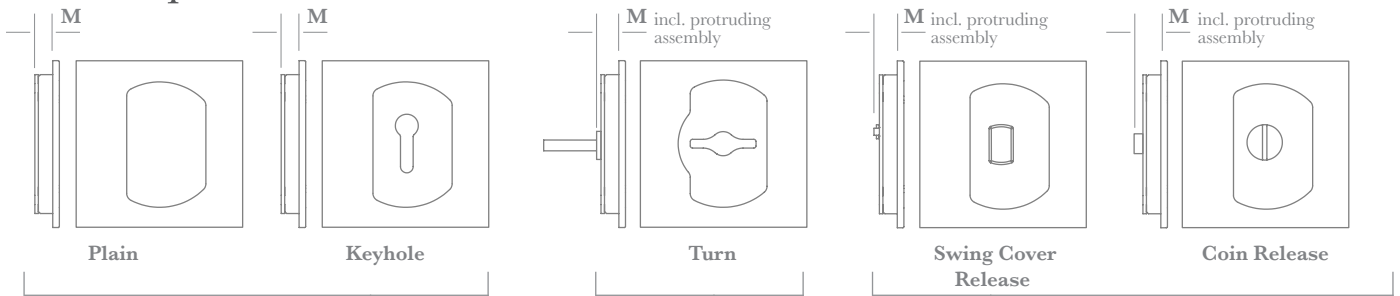
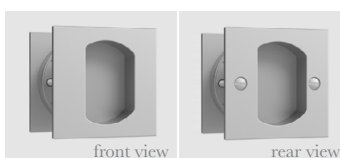

PLATE DESIGNS	Face Plate Thickness T	M Mortice Depths								
		Plain Keyhole			Turn NB. Mortice depths shown below include the extra 2mm required to accommodate the turn assembly.			Swing Cover Release Coin Release NB. Mortice depths shown below include the extra 2.5mm required to accommodate the swing cover assembly and coin release.		
		14MM	17MM	21MM	14MM	17MM	21MM	14MM	17MM	21MM
32--, 67--, 68--, 87--	4	11	14	18	13	16	20	13.5	16.5	20.5
47--, 49--, 59--, 60--, 66--	3	12	15	19	14	17	21	14.5	17.5	21.5

## Back-to-Back Fixing



Plain (non-functioning) Pulls are available as pairs back-to-back fixed. Please contact us for coding information.



# Flush Pulls - Plain

A choice of nine Flush Pull designs, all available in 14 sizes with three depth options, and either Face, Pocket or Adhesive fixed - all offered with a choice of functions. Please note: Adhesive fix is not recommended for the Turn option. Custom sizes are available upon request - surcharge may apply.

6860A/11MM/AF/IBU

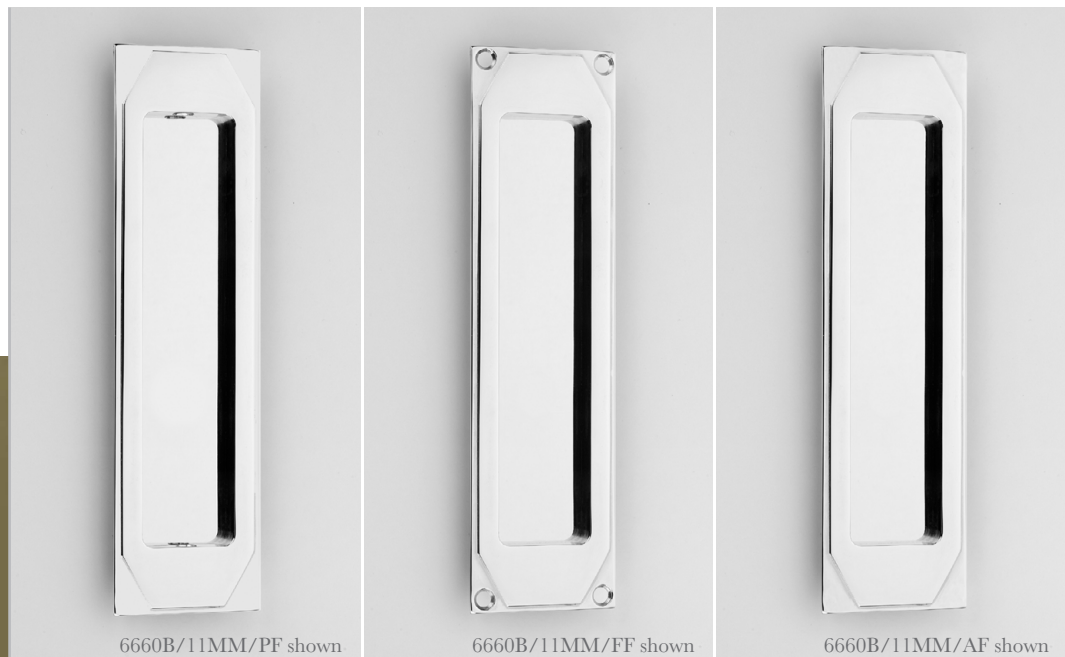

6660B/11MM/PF shown

6660B/11MM/FF shown

6660B/11MM/AF shown

▲ **PF** pocket fixed  
(available 11 & 14mm depths only)

▲ **FF** face fixed (not available on sizes SQA, SQB, SQC)

▲ **AF** adhesive fixed

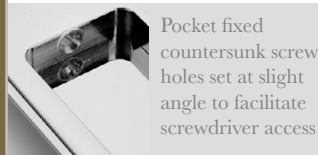

Pocket fixed countersunk screw holes set at slight angle to facilitate screwdriver access



Overall Depth	9*	11	14
Code	9MM	11MM	14MM

\* pocket fixing not available 9mm deep



## Fixings

Face fixed & Pocket fixed versions supplied with finish matched no.6 x 19mm wood screws.

Swing Cover Release versions supplied with nickel plated key.

## How to Order

Refer to page DF4:020 for size codes:

- 1) select PLATE DESIGN (e.g. 66--)
- 2) add 60 for PLAIN version (e.g. 6660)
- 3) add SIZE (e.g. 6660B)
- 4) choose DEPTH OPTION (e.g. 6660B/11MM).
- 5) choose FIXING METHOD (e.g. 6660B/11MM/PF)
- 6) add FINISH (e.g. 6660B/11MM/PF/PC).

**Finishes** - See our price list or website for finish availability.

## FACE PLATE DESIGNS (51mm width shown)

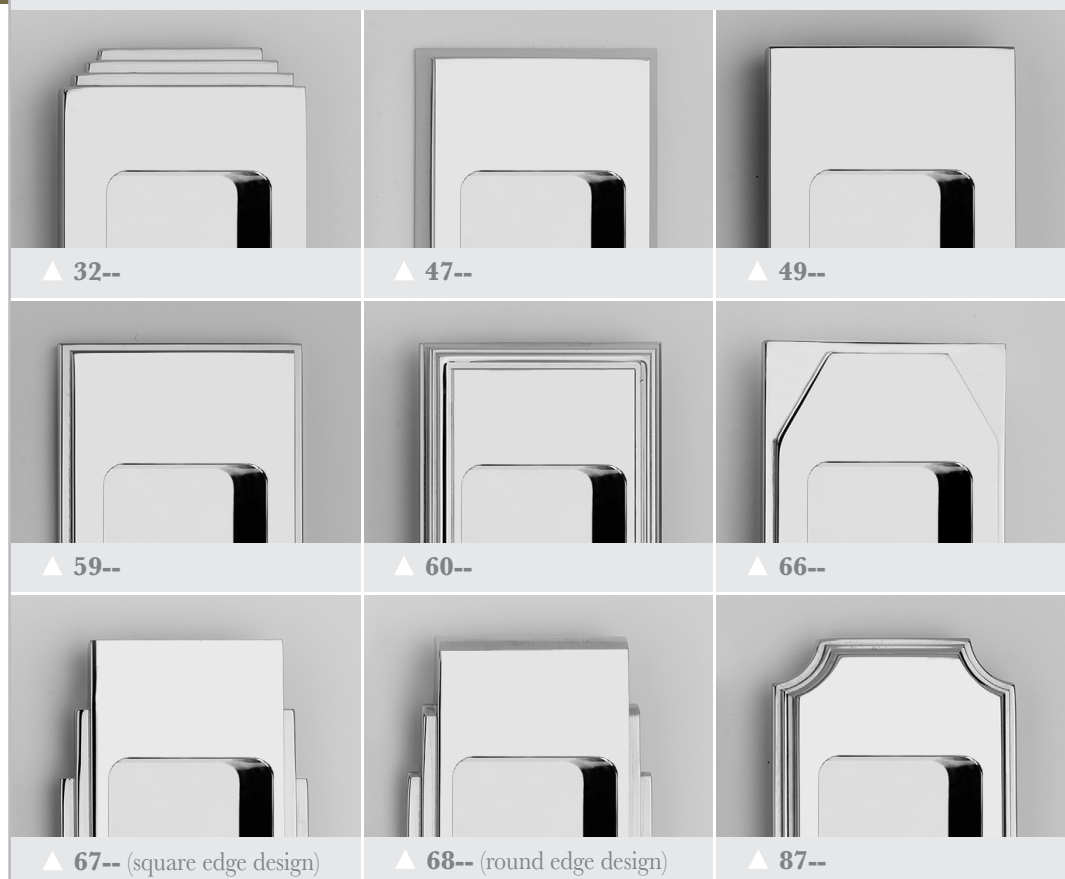

▲ 32--

▲ 47--

▲ 49--

▲ 59--

▲ 60--

▲ 66--

▲ 67-- (square edge design)

▲ 68-- (round edge design)

▲ 87--

# Flush Pulls - size options & dimensions

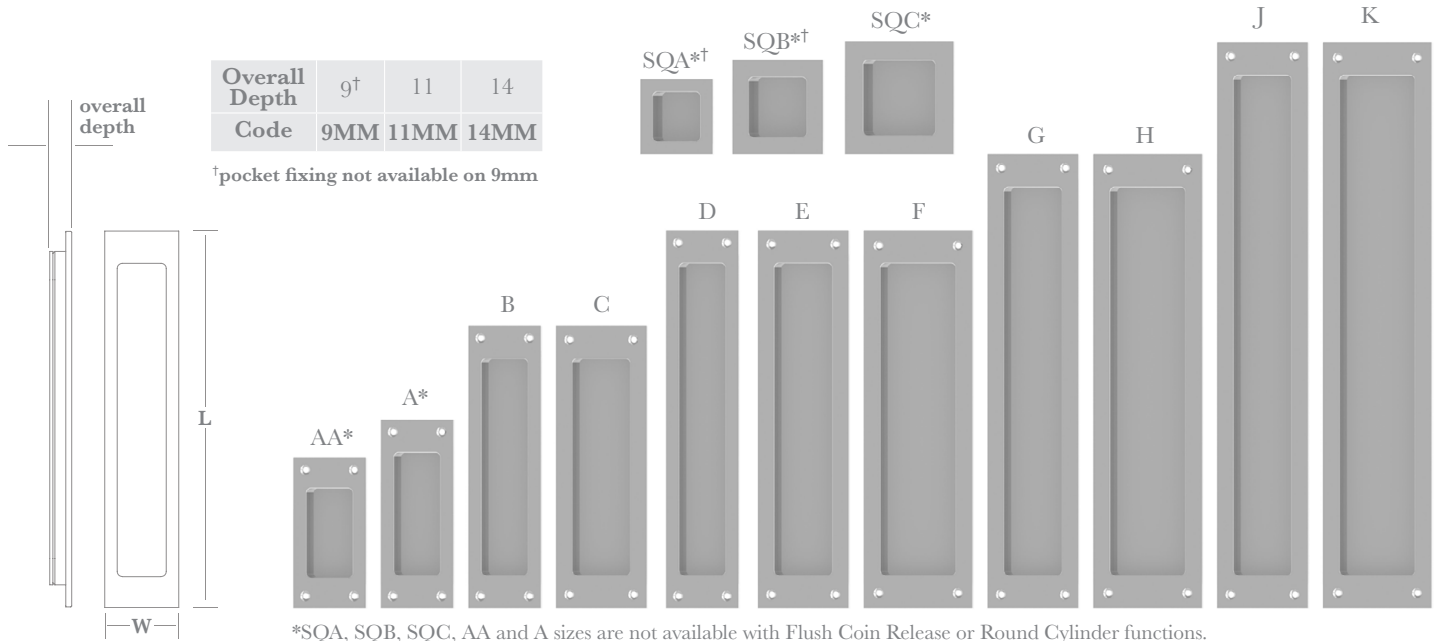

\*SQA, SQB, SQC, AA and A sizes are not available with Flush Coin Release or Round Cylinder functions.

<sup>†</sup>SQA and SQB are also not available with Swing Cover Release function.

	SQA	SQB	SQC	AA	A	B	C	D	E	F	G	H	J	K
Size (L x W)	51 x 51	64 x 64	76 x 76	102 x 51	127 x 51	190 x 51	190 x 64	254 x 51	254 x 64	254 x 76	305 x 64	305 x 76	380 x 64	380 x 76
Overall Aperture Size <sup>∅</sup> (L x W)	33 x 33	40 x 40	50 x 50	60 x 32	82 x 32	145 x 32	145 x 40	209 x 32	209 x 40	209 x 52	260 x 40	260 x 52	335 x 40	335 x 52
Mortise Size (L x W)	43 x 39	50 x 50	60 x 63	70 x 39	95 x 39	158 x 41	158 x 55	222 x 41	222 x 55	222 x 67	273 x 55	273 x 67	348 x 55	348 x 67
32 Series Design Size (L x W)	69 x 51	82 x 64	94 x 76											

Custom sizes are available upon request - surcharge may apply.

(<sup>∅</sup>except Pulls with Round Cylinder Hole Sizes B & C)

## Functions, Mortise Depths & Face Plate Thicknesses

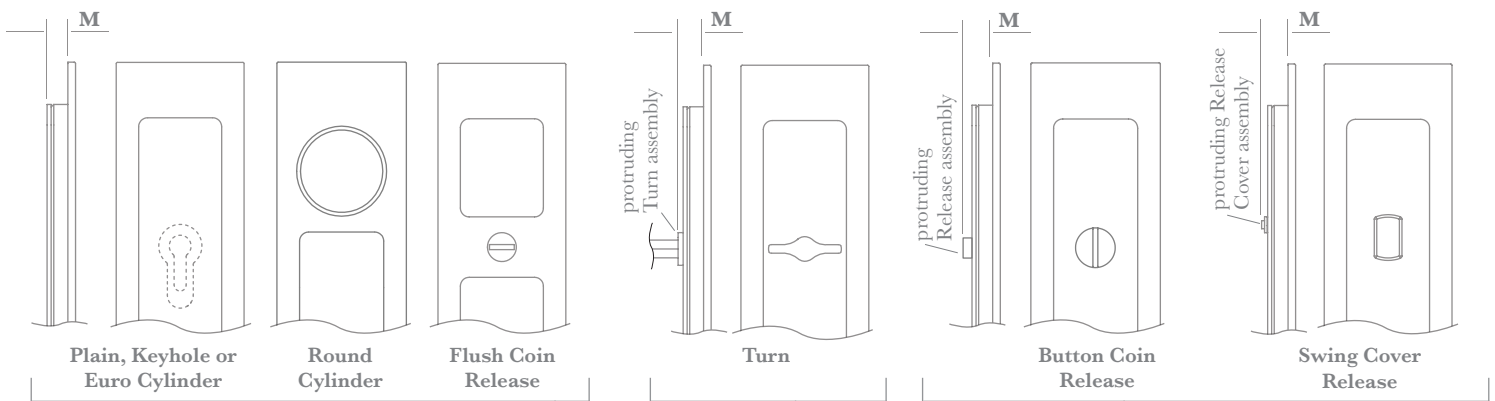





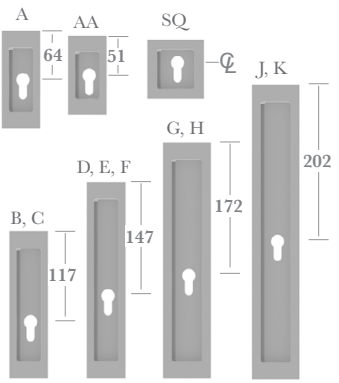
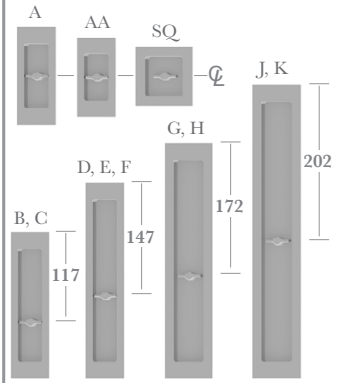
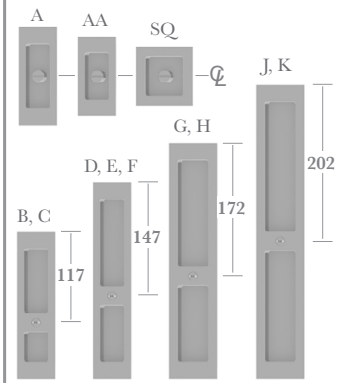
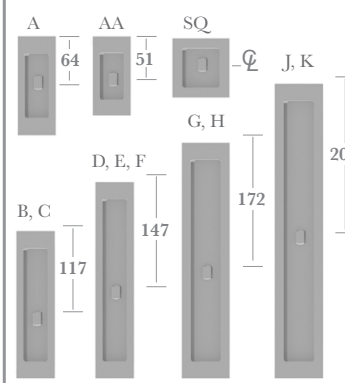
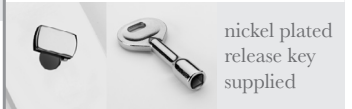

PLATE DESIGN	Face Plate Thickness <sup>T</sup>	M Mortise Depths								
		Plain Cylinder Coin Release Keyhole Euro Cylinder Cutout			Turn NB. Mortise depths shown below include the extra 2mm required to accommodate the turn assembly.			Swing Cover Release NB. Mortise depths shown below include the extra 2.5mm required to accommodate the swing cover assembly.		
		9MM	11MM	14MM	9MM	11MM	14MM	9MM	11MM	14MM
32--, 67--, 68--, 87--	4	6	8	11	8	10	13	8.5	10.5	13.5
47--, 49--, 59--, 60--, 66--	3	7	9	12	9	11	14	9.5	11.5	14.5



# Flush Pulls - Keyhole, Euro & Privacy Functions

Lock Functions	Privacy Functions - Shown set up to work with 7560 type lock (see below)			
 <p>▲ Euro Cylinder Cutout</p>	 <p>6658B/11MM/PF shown</p>	 <p>6655B/11MM/PF shown</p>	 <p>6640B/11MM/PF shown</p>	 <p>6659B/11MM/PF shown</p>
 <p>▲ Standard Keyhole</p>				
 <p>▲ --09 Pull with Euro Cylinder Cutout --10 Pull with Keyhole</p>	 <p>▲ Pull with Turn --08 (square spindle orientation) --58 (diamond spindle orientation)</p>	 <p>▲ --55 Pull with Flush Coin Release --40 Pull with Button Coin Release</p>	 <p>▲ --59 Pull with Swing Cover Release</p>	



## Fixings

Supplied with finish matched no.6 x 19mm wood screws. Flush Pulls with Turns are supplied with factory fitted 5mm spindles suitable for doors up to 45mm thick if the face plate is surface mounted (or 51mm thick if flush fitted). Longer spindles are available upon request for doors up to 80mm thick.

## How to Order

Refer to pages DF4:010 & 020 for size & design options:

- 1) select PLATE DESIGN (e.g. 66--)
- 2) add FUNCTION (e.g. 6658)
- 3) add SIZE (e.g. 6658F).
- 4) choose DEPTH OPTION (e.g. 6658F/11MM)
- 5) choose FIXING METHOD (e.g. 6658F/11MM/FF)
- 6) add FINISH (e.g. 6658F/11MM/FF/PC)

**NB. Custom sizes, and custom Turn/Release positioning, are available upon request - surcharge may apply.**

**Finishes** - See our price list or website for finish availability.

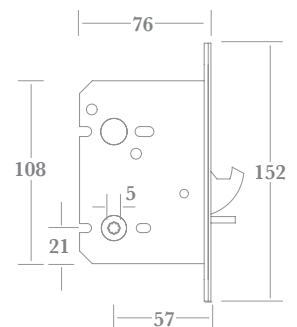
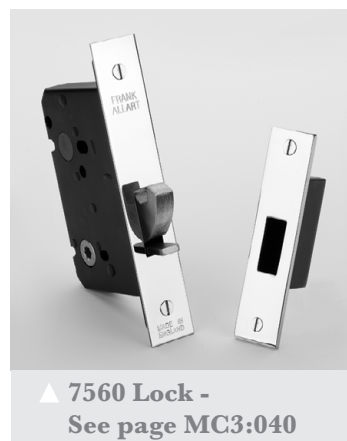

# Flush Pulls - Privacy & Cylinder Lock Functions

Shown set up to work with 7565 type lock (see below)

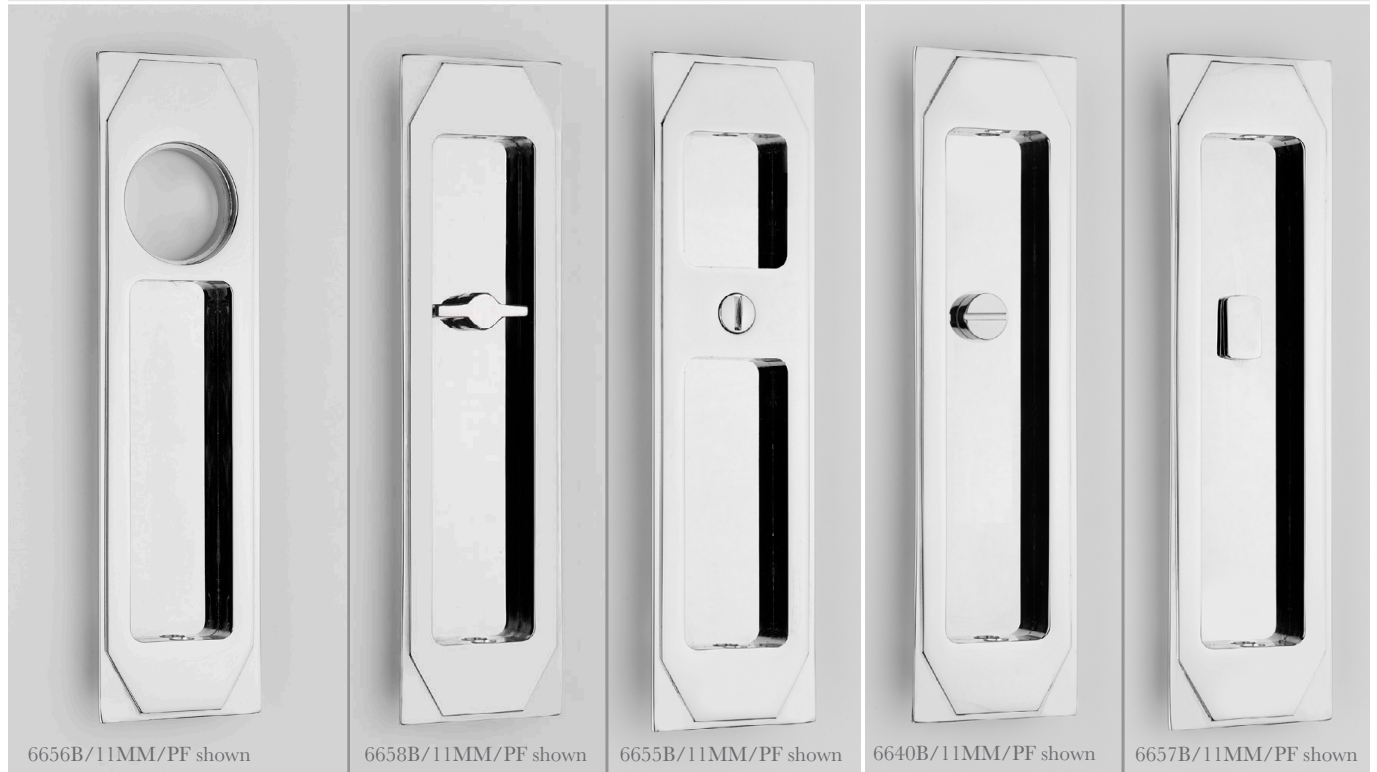

<p>machined to suit US standard cylinder (not supplied)</p>			
<p>▲ --56 Flush Pull with Cylinder Hole</p>	<p>▲ --58 Flush Pull with Turn (diamond spindle orientation)</p>	<p>▲ --55 Pull with Flush Coin Release --40 Pull with Button Coin Release</p>	<p>▲ --57 Flush Pull with Swing Cover Release</p>



## Fixings

Supplied with finish matched no.6 x 19mm wood screws. Flush Pulls with Turns are supplied with factory fitted 5mm spindles suitable for doors up to 45mm thick if the face plate is surface mounted (or 51mm thick if flush fitted). Longer spindles are available upon request for doors up to 80mm thick.

## How to Order

Refer to pages DF4:010 & 020 for size & design options:

- 1) select PLATE DESIGN (e.g. 66--)
- 2) add FUNCTION (e.g. 6658)
- 3) add SIZE (e.g. 6658F).
- 4) choose DEPTH OPTION (e.g. 6658F/11MM)
- 5) choose FIXING METHOD (e.g. 6658F/11MM/FF)
- 6) add FINISH (e.g. 6658F/11MM/FF/PC)

**NB. Custom sizes, and custom Turn/Release positioning, are available upon request - surcharge may apply.**

**Finishes** - See our price list or website for finish availability.



▲ 7565 Lock - See page MC3:050

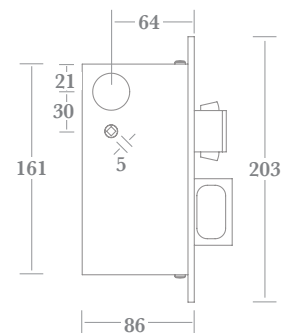

# Flush Pulls - Lipped Designs

A choice of nine Lipped Flush Pull designs suitable for both hinged doors and sliding drawers. All available in 14 sizes with three depth options, and either Face, Pocket or Adhesive fixed, all offered with a choice of functions. The 51mm wide versions have an offset aperture and are a single sided lip design; the 64mm and 76mm wide versions are lipped both sides. Custom sizes are available upon request - surcharge may apply.

3207B/17MM/AF/PC



3207B/17MM/PF shown

3207B/17MM/FF shown

3207B/17MM/AF shown

▲ **PF** pocket fixed

▲ **FF** face fixed (not available on sizes SQA, SQB, SQC)

▲ **AF** adhesive fixed



Pocket fixed countersunk screw holes set at slight angle to facilitate screwdriver access



Overall Depth	14	17	21
Code	14MM	17MM	21MM

**FUNCTION OPTIONS - see pages DF4:046**

## Fixings

Face fixed versions supplied with finish matched wood screws:  
17mm & 21mm depth: no.6 x 32mm;  
14mm no. 6 x 25mm.

Pocket fixed versions supplied with finish matched no.6 x 19mm wood screws.

Swing Cover Release versions supplied with nickel plated key.

## How to Order

Refer to page DF4:046 for size codes:

- 1) select PLATE DESIGN (e.g. 6607)
- 2) add SIZE (e.g. 6607B)
- 3) choose DEPTH OPTION (e.g. 6607B/14MM).
- 4) choose FIXING METHOD (e.g. 6607B/14MM/PF)
- 5) add FINISH (e.g. 6607B/14MM/PF/PC)
- 6) choose FUNCTION if required (e.g. 6607B/14MM/PF/PC/KH).

**Finishes** - See our price list or website for finish availability.

## FACE PLATE DESIGNS (51mm width shown)

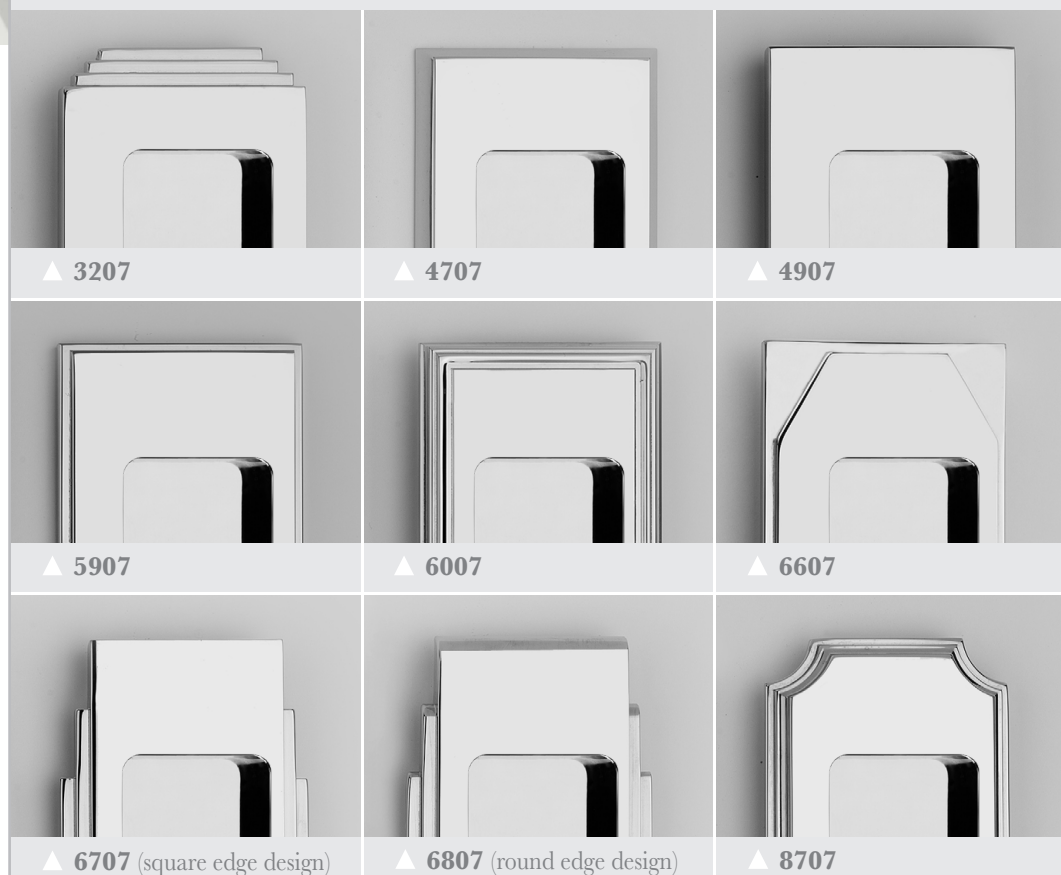

▲ 3207

▲ 4707

▲ 4907

▲ 5907

▲ 6007

▲ 6607

▲ 6707 (square edge design)

▲ 6807 (round edge design)

▲ 8707

# Flush Pulls - Lipped Designs

Size options & dimensions

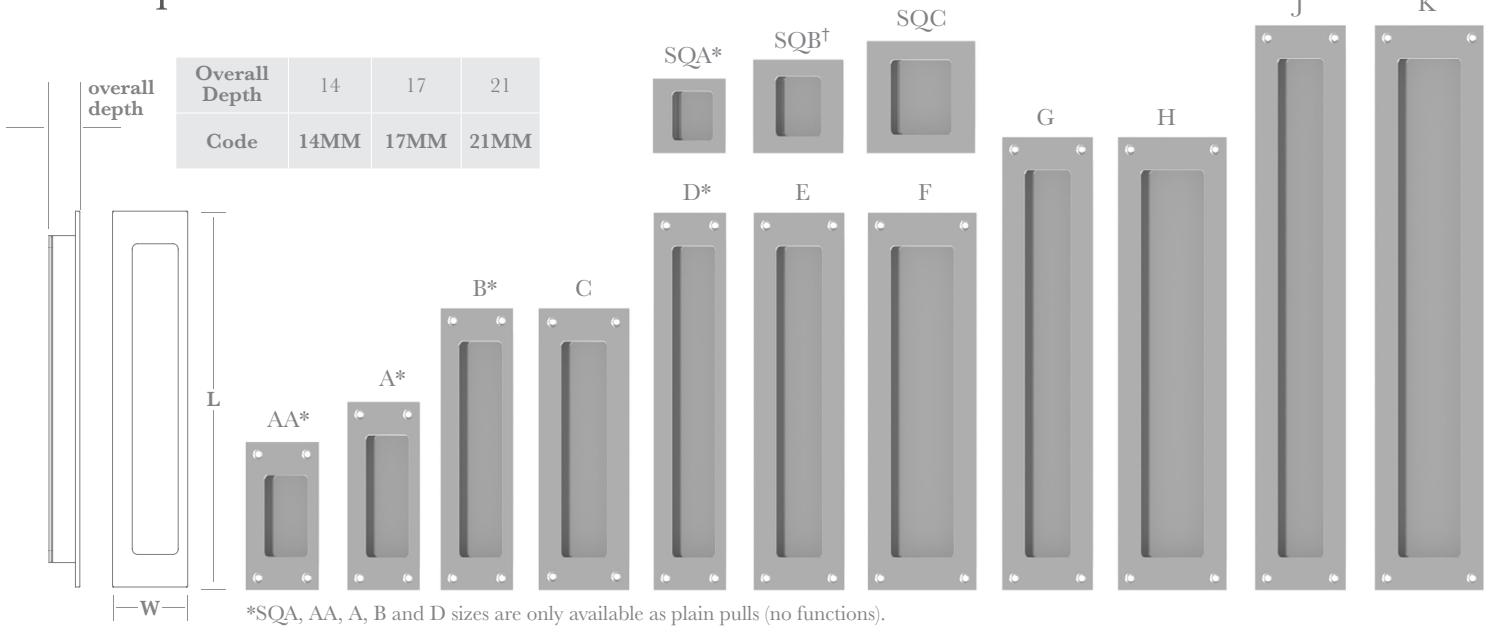
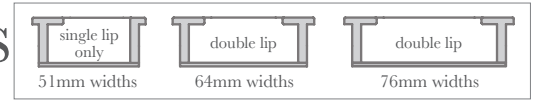

\*SQA, AA, A, B and D sizes are only available as plain pulls (no functions).

†SQB is not available with Swing Cover Release function.

	SQA	SQB	SQC	AA	A	B	C	D	E	F	G	H	J	K
Size (L x W)	51 x 51	64 x 64	76 x 76	102 x 51	127 x 51	190 x 51	190 x 64	254 x 51	254 x 64	254 x 76	305 x 64	305 x 76	380 x 64	380 x 76
Overall Aperture Size (L x W)	33 x 28	40 x 32	50 x 43	60 x 30	82 x 30	145 x 30	145 x 32	209 x 30	209 x 32	209 x 44	260 x 32	260 x 44	335 x 32	335 x 44
Mortise Size (L x W)	43 x 39	50 x 50	60 x 63	70 x 43	95 x 43	158 x 43	158 x 55	222 x 43	222 x 55	222 x 67	273 x 55	273 x 67	348 x 55	348 x 67
32 Series Design Size (L x W)	69 x 51	82 x 64	94 x 76											

Custom sizes are available upon request - surcharge may apply.

## Functions, Mortise Depths & Face Plate Thicknesses

NB. Please see page DF4:030 for lock centre positions

Size C shown except where indicated

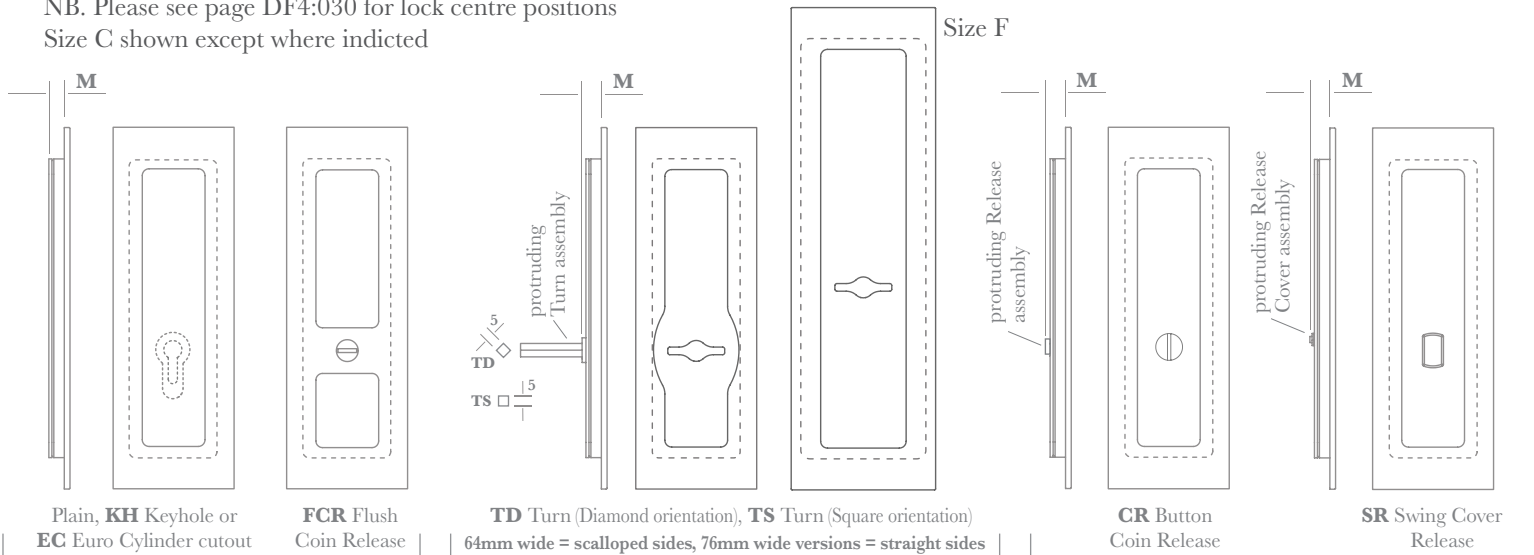

PLATE DESIGN	Face Plate Thickness T	M Mortise Depths								
		Plain Keyhole Euro Cylinder cutout Flush Coin Release			Turn NB. Mortise depths shown below include the extra 2mm required to accommodate the turn assembly.			Swing Cover Release Button Coin Release NB. Mortise depths shown below include the extra 2.5mm required to accommodate the swing cover assembly.		
		14MM	17MM	21MM	14MM	17MM	21MM	14MM	17MM	21MM
32--, 67--, 68--, 87--	4	11	14	18	13	16	20	13.5	16.5	20.5
47--, 49--, 59--, 60--, 66--	3	12	15	19	14	17	21	14.5	17.5	21.5



nickel plated release key supplied with Swing Cover Release

# Flush Pulls - Traditional Lipped Designs

A selection of traditional lipped Flush Pulls suitable for sliding doors and drawers.

The lipped feature renders them suitable for use as drawer pulls and on lightweight hinged cabinet doors. These Pulls are not recommended for full size hinged doors.

The 2713, 2714 & 9538 designs are supplied with pocket fixing at the top and bottom of the aperture, as shown below.



▲ 2713



▲ 2714



▲ 9538



▲ 1155



▲ 1157



▲ 1159



▲ 3944

**FLUSH FIT INSTALLATION**  
As these Pulls are hand finished the outer face edge dimensions may vary and are not suitable for pre-morticed installations

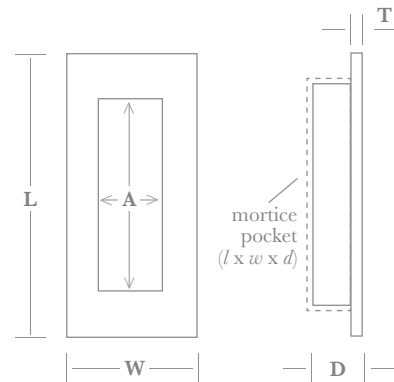

## Fixings

Face fixed Pulls supplied with finish matched no. 6 x 25mm wood screws.  
Pocket fixed Pulls supplied with finish matched no. 6 x 19mm wood screws.

## How to Order

- 1) select PULL (e.g. 1157)
  - 2) add FINISH (e.g. 1157PB)
- 1155, 2713, 2714 & 9538 - add SIZE (e.g. 1155PB/B).

**Finishes** - See our price list or website for finish availability.

	1155, 2713 2714, 9538		1157	1159	3944
	A	B			
Size (L x W)	90 x 41	103 x 51	89 x 41	114 x 64	100 x 50
A (aperture)	61 x 21	71 x 25	62 x 19	83 x 34	61 x 21
D (depth)	16	19	16	21	14
T (thickness)	4	4	3	4	6
mortice size (l x w x d)	72 x 30 x 13	84 x 36 x 16	72 x 30 x 14	98 x 51 x 18	72 x 30 x 9

# Flush Ring Handles & Coin Releases

A selection of Flush Ring Handles and Coin Releases in three sizes, along with a fully flush version suitable for Squash Court doors, floor fixing for trapdoors, or simply for improved aesthetics.

A smaller Coin Release is also available.

All Coins Releases are supplied with a 5mm - 8mm conversion spindle.

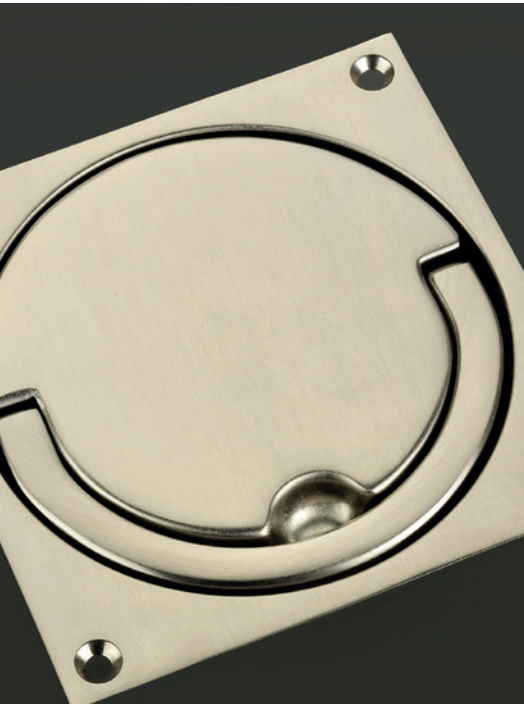

▲ 1086



▲ 1084



▲ 1085



▲ 1083



▲ 1080



▲ 1082

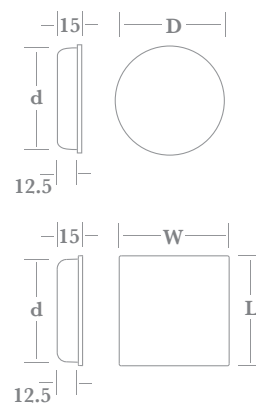
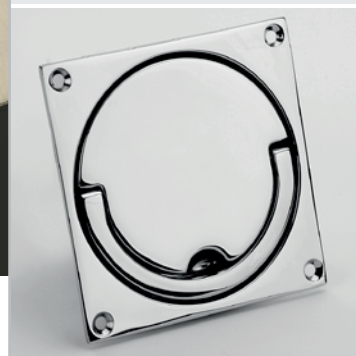

1080, 1082 1084, 1085	A	B	C
D	Ø 63	Ø 73	Ø 88
d	Ø 61	Ø 71	Ø 86

1083 & 1086	A	B	C
L x W	65 x 65	75 x 75	90 x 90
d	Ø 61	Ø 71	Ø 86

1087	
L x W	90 x 90
d	Ø 86

## Fixings

1084-7 supplied with finished matched no.6 x 19mm wood screws and 8mm x 90mm spindles.

1080-3 supplied with no.6 x 19mm wood screws and a 5mm square spindle and a 5mm to 8mm conversion spindle.

1090 supplied with finish matched no.4 x 13mm wood screws, a 5mm square spindle and a 5mm to 8mm conversion spindle.

## How to Order

- 1) select HANDLE/RELEASE (e.g. **1085**)
- 2) add FINISH (e.g. **1085PB**)
- 3) add SIZE, except 1087 & 1090 (e.g. **1085PB/A**).

For FIXED DEAD/DUMMY add FD to code (e.g. **1086PB/A/FD**).

**Finishes** - See our price list or website for finish availability.

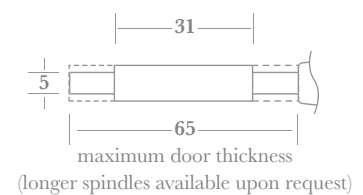
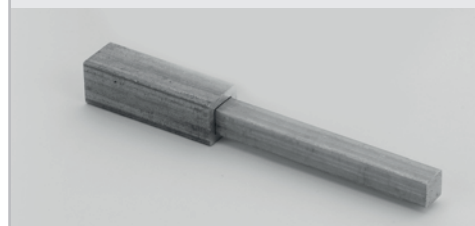
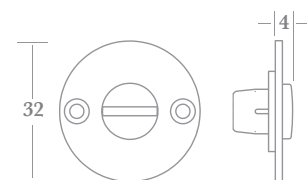



# Door Edge Pulls

Three different designs of Door Edge Pulls. The 4377 & 4378 are both robust, heavy duty designs suitable for all door sizes & weights, whilst the 4380 is best suited for light/hollow core doors only.

A particular feature of the 4378 is the finish matched Pull, Face Plate, Release Button, and screws.



▲ 4377

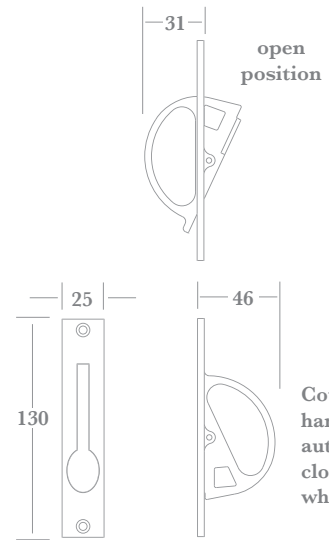

Counter-balanced handle returns automatically to closed position when released.



▲ 4380 (suitable for light/hollow core doors only)

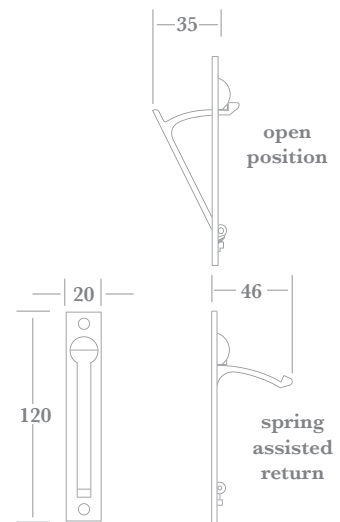

## Fixings

4377 supplied with finish matched no.8 x 25mm wood screws.

4380 supplied with finish matched no.6 x 25mm wood screws.

4378 supplied with no.8 x 25mm wood screws and finish matched face plate machine screws.

## How to Order

- 1) select PULL (e.g. 4377)
- 2) add FINISH (e.g. 4377PC)

**Finishes** - See our price list or website for finish availability.



▲ 4378

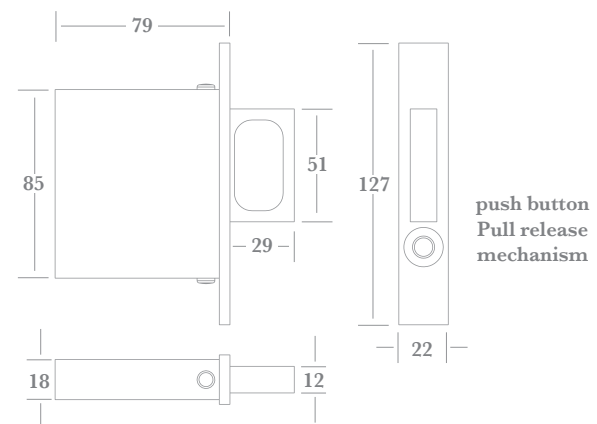

Light touch Pull retraction or automatic retraction when Pull contacts door frame.

